



















KEY

-  You Are Here
-  Evacuation Route
-  Exit
-  Emergency Assembly Point
-  Restroom
-  Automated External Defibrillator
-  Fire Extinguisher
-  Fire Alarm (Pull Station)
-  Fire Alarm Control Panel
-  Fire Sprinkler Shut-off
-  Stand Pipe or FDC
-  Symbol of Accessibility
-  Tornado/Severe Thunderstorm
Refuge Areas
-  First Aid Kit
-  Eye Wash/Safety Shower
-  Spill Kit

IF THERE IS AN EVACUATION EMERGENCY:

- Assist persons with disabilities
- Exit the building using the nearest exit DO NOT USE ELEVATORS!
- Report to the nearest designated area.
- Call 911 (9-911 if on a campus phone)
- Call Public Safety at 605-394-6100
- Do not re-enter until authorized to do so.

CAMPUS ESCORT SERVICE:

Public Safety Provides Escort Services: To arrange an escort, call 605-394-6100, and a Public Safety Employee will escort you from any campus building to another.

Main Menu

















EMERGENCY ASSEMBLY POINT MAP

List of Buildings (click building):

- [Vanderboom Research Lab \(V-Lab\)](#)
- [Chemical and Biological Engineering and Chemistry Building \(CBEC\)](#)
- [Civil/Mechanical](#)
- [Classroom Building](#)
- [Computational Mechanics Laboratory](#)
- [Connolly Hall](#)
- [Electrical Engineering and Physics](#)
- [Facility Services](#)
- **Foundry (Not Available)**
- [Howard Peterson Hall](#)
- [James E. Martin Paleontology Research Center](#)
- [King Center](#)
- [Deveraux Library](#)
- [McLaury](#)
- [Mineral Industries](#)
- [O'Harra](#)
- [Music Center \(Old Gym\)](#)
- [Palmerton Hall](#)
- [Placer Hall](#)
- [Rocker Square 1](#)
- [Rocker Square 2](#)
- [Surbeck Center](#)
- [Tech Development Laboratory](#)



KEY

-  You Are Here
-  Evacuation Route
-  Exit
-  Emergency Assembly Point
-  Restroom
-  Automated External Defibrillator
-  Fire Extinguisher
-  Fire Alarm (Pull Station)
-  Fire Alarm Control Panel
-  Fire Sprinkler Shut-off
-  Stand Pipe or FDC
-  Symbol of Accessibility
-  Tornado/Severe Thunderstorm Refuge Areas
-  First Aid Kit
-  Eye Wash/Safety Shower
-  Spill Kit

IF THERE IS AN EVACUATION EMERGENCY:

- Assist persons with disabilities
- Exit the building using the nearest exit **DO NOT USE ELEVATORS!**
- Report to the nearest designated area.
- Call 911 (9-911 if on a campus phone)
- Call Public Safety at 605-394-6100
- Do not re-enter until authorized to do so.

CAMPUS ESCORT SERVICE:

Public Safety Provides Escort Services: To arrange an escort, call 605-394-6100, and a Public Safety Employee will escort you from any campus building to another.

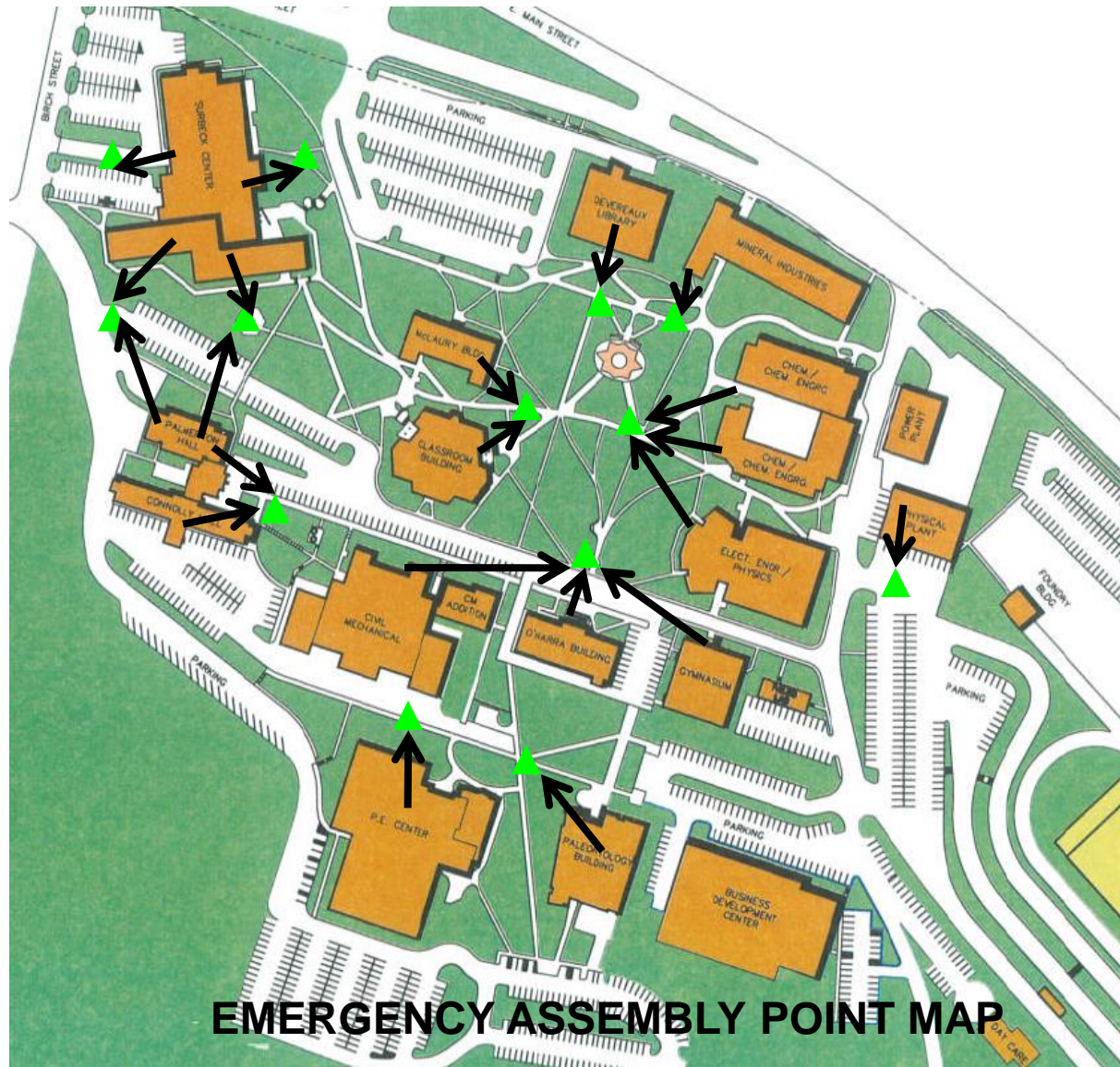

EMERGENCY ASSEMBLY POINT MAP

Campus Emergency Numbers

Emergency 911 (9-911 from a campus phone)

SDSMT Public Safety (605)394-6100

Emergency Information Recording (605)394-2210



















SOUTH DAKOTA MINES

An engineering, science and technology university

Building Managers

Jessica Humphrey
Todd Curtis

KEY

-  You Are Here
-  Evacuation Route
-  Exit
-  Emergency Assembly Point
-  Restroom
-  Automated External Defibrillator
-  Fire Extinguisher
-  Fire Alarm (Pull Station)
-  Fire Alarm Control Panel
-  Fire Sprinkler Shut-off
-  Stand Pipe or FDC
-  Symbol of Accessibility
-  Tornado/Severe Thunderstorm
Refuge Areas
-  First Aid Kit
-  Eye Wash/Safety Shower
-  Spill Kit

 Emergency Assembly Point – Center of North Parking Lot

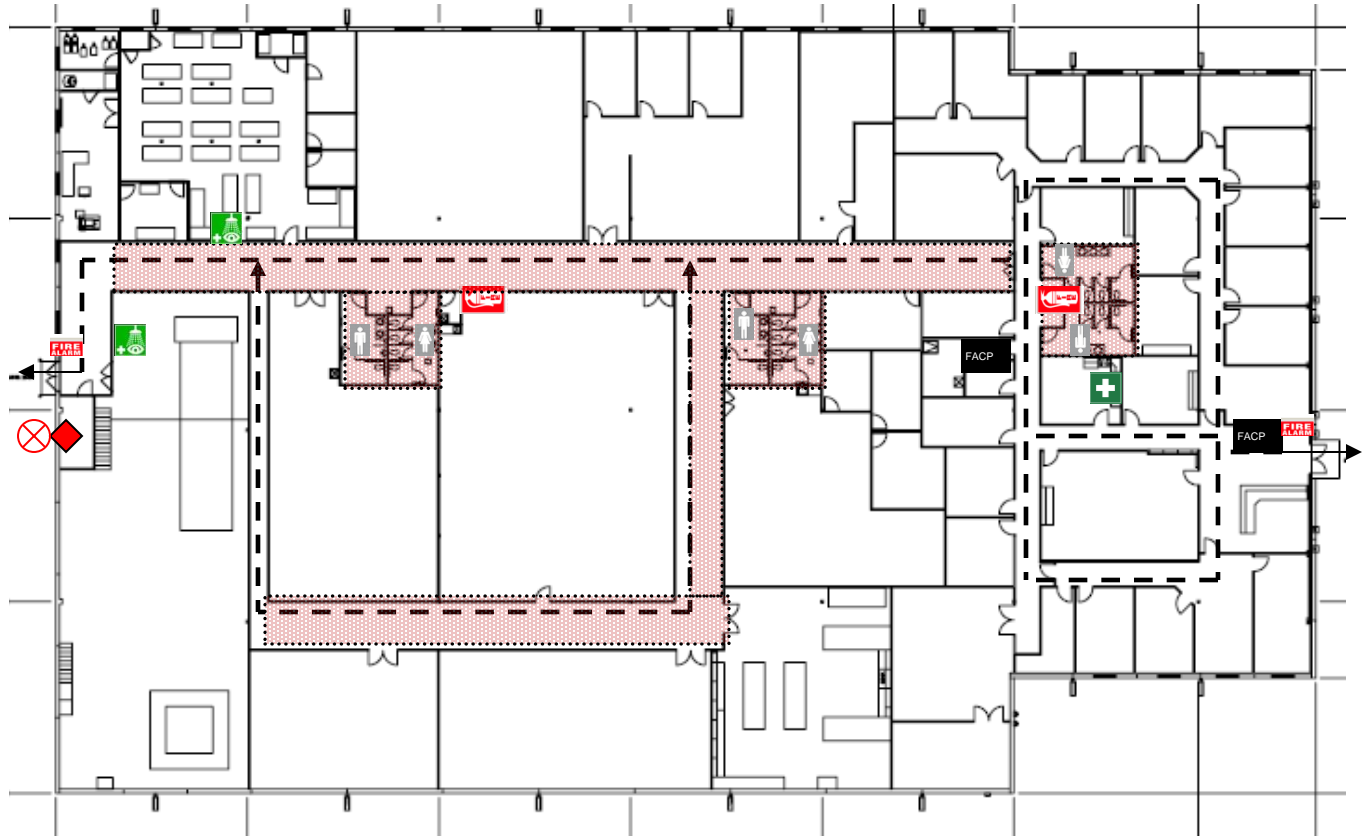

IF THERE IS AN EVACUATION EMERGENCY:

- Assist persons with disabilities
- Exit the building using the nearest exit **DO NOT USE ELEVATORS!**
- Report to the nearest designated area.
- Call 911 (9-911 if on a campus phone)
- Call Public Safety at 605-394-6100
- Do not re-enter until authorized to do so.

CAMPUS ESCORT SERVICE:

Public Safety Provides Escort Services: To arrange an escort, call 605-394-6100, and a Public Safety Employee will escort you from any campus building to another.

Vanderboom Research Lab (V-Lab)

Campus Emergency Numbers

Emergency 911 (9-911 from a campus phone)

SDSM&T Public Safety (605)394-6100

Emergency Information Recording (605)394-2210



















SOUTH DAKOTA MINES

An engineering, science and technology university

Building Managers

Darren Schwede
Morgan Thomas-Abbott

KEY

-  You Are Here
-  Evacuation Route
-  Exit
-  Emergency Assembly Point
-  Restroom
-  Automated External Defibrillator
-  Fire Extinguisher
-  Fire Alarm (Pull Station)
-  Fire Alarm Control Panel
-  Fire Sprinkler Shut-off
-  Stand Pipe or FDC
-  Symbol of Accessibility
-  Tornado/Severe Thunderstorm Refuge Areas
-  First Aid Kit
-  Eye Wash/Safety Shower
-  Spill Kit



 Quad Area (Upwind in the event of a chemical incident.)

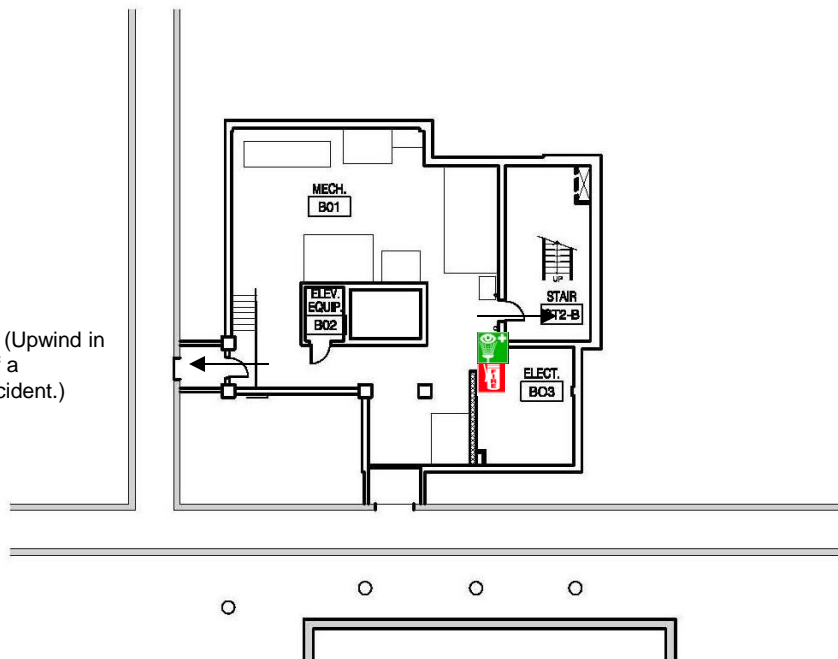

IF THERE IS AN EVACUATION EMERGENCY:

- Assist persons with disabilities
- Exit the building using the nearest exit **DO NOT USE ELEVATORS!**
- Report to the nearest designated area.
- Call 911 (9-911 if on a campus phone)
- Call Public Safety at 605-394-6100
- Do not re-enter until authorized to do so.

CAMPUS ESCORT SERVICE:

Public Safety Provides Escort Services: To arrange an escort, call 605-394-6100, and a Public Safety Employee will escort you from any campus building to another.

Chemical and Biological Engineering Chemistry Building (CBEC)– Basement

Campus Emergency Numbers

Emergency 911 (9-911 from a campus phone)

SDSMT Public Safety (605)394-6100

Emergency Information Recording (605)394-2210



SOUTH DAKOTA MINES

An engineering, science and technology university

Building Managers

Darren Schwede
Morgan Thomas-Abbott

KEY

- You Are Here
- Evacuation Route
- Exit
- Emergency Assembly Point
- Restroom
- Automated External Defibrillator
- Fire Extinguisher
- Fire Alarm (Pull Station)
- Fire Alarm Control Panel
- Fire Sprinkler Shut-off
- Stand Pipe or FDC
- Symbol of Accessibility
- Tornado/Severe Thunderstorm Refuge Areas
- First Aid Kit
- Eye Wash/Safety Shower
- Spill Kit

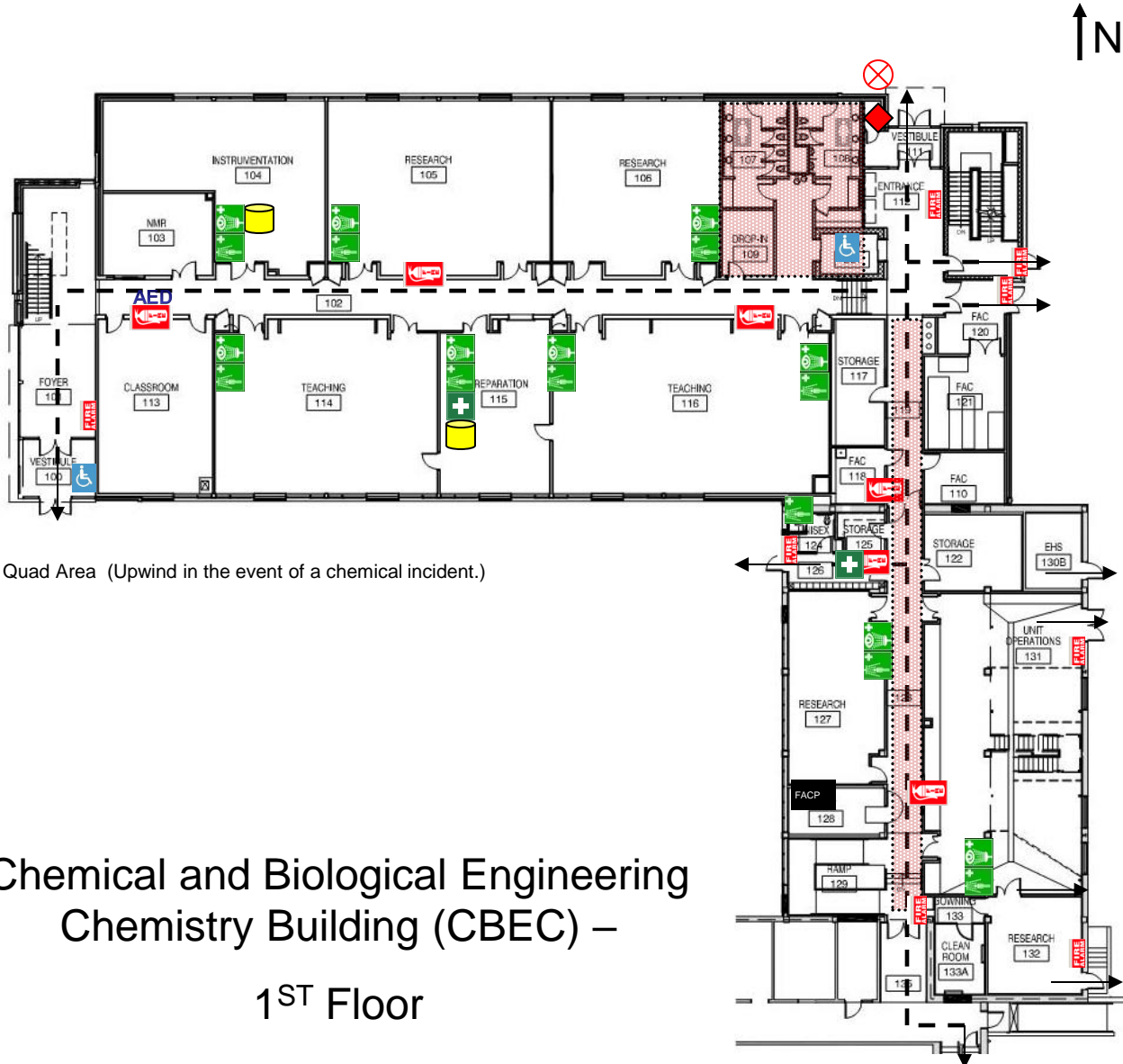

Chemical and Biological Engineering Chemistry Building (CBEC) –

1ST Floor

IF THERE IS AN EVACUATION EMERGENCY:

- Assist persons with disabilities
- Exit the building using the nearest exit **DO NOT USE ELEVATORS!**
- Report to the nearest designated area.
- Call 911 (9-911 if on a campus phone)
- Call Public Safety at 605-394-6100
- Do not re-enter until authorized to do so.

CAMPUS ESCORT SERVICE:

Public Safety Provides Escort Services: To arrange an escort, call 605-394-6100, and a Public Safety Employee will escort you from any campus building to another.

Campus Emergency Numbers

Emergency 911 (9-911 from a campus phone)

SDSM&T Public Safety (605)394-6100

Emergency Information Recording (605)394-2210



SOUTH DAKOTA MINES

An engineering, science and technology university

Building Managers

Darren Schwede
Morgan Thomas-Abbott

KEY

- You Are Here
- Evacuation Route
- Exit
- Emergency Assembly Point
- Restroom
- Automated External Defibrillator
- Fire Extinguisher
- Fire Alarm (Pull Station)
- Fire Alarm Control Panel
- Fire Sprinkler Shut-off
- Stand Pipe or FDC
- Symbol of Accessibility
- Tornado/Severe Thunderstorm Refuge Areas
- First Aid Kit
- Eye Wash/Safety Shower
- Spill Kit

In the event of a tornado, please proceed to areas marked on the first floor map.

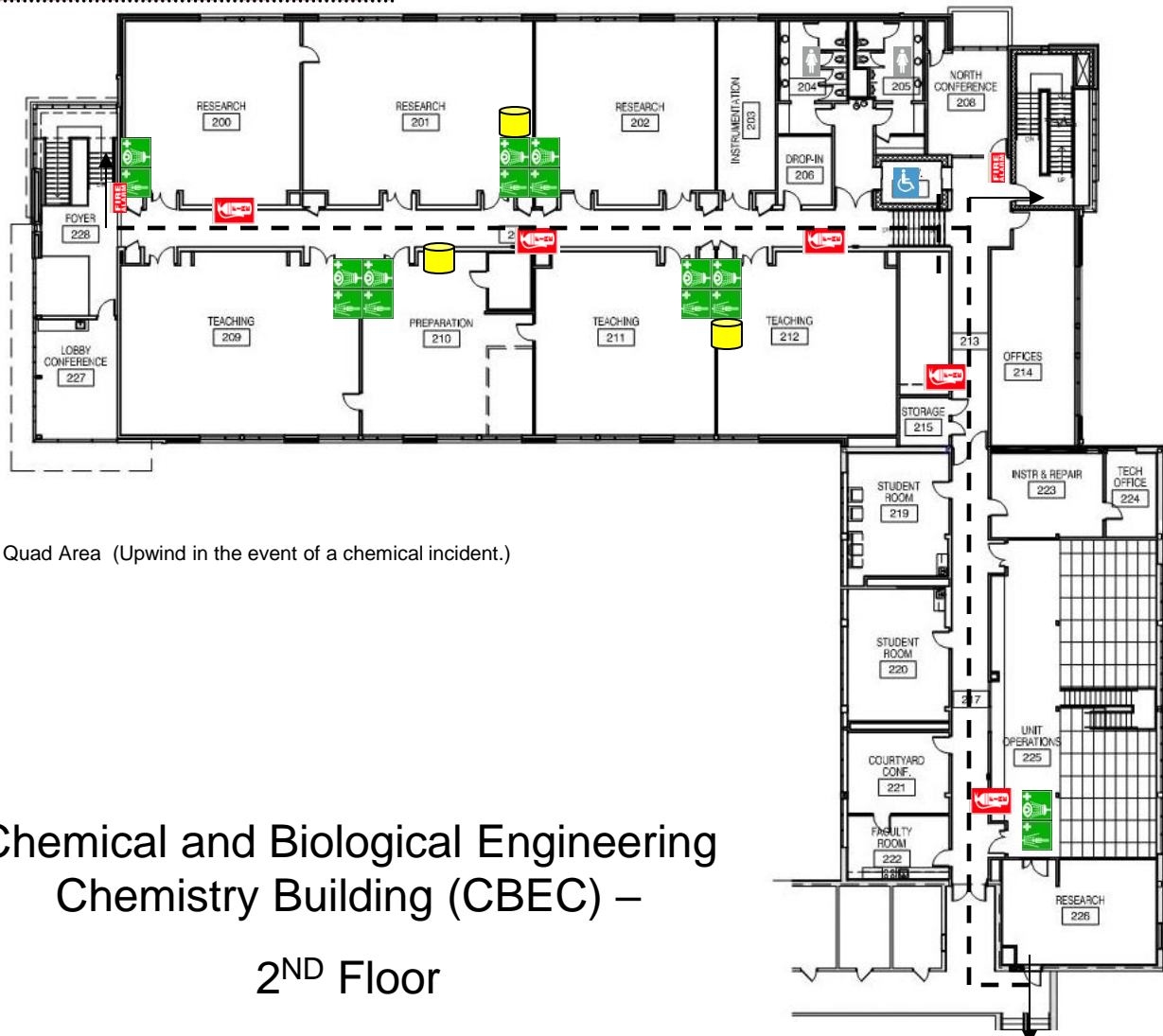

Quad Area (Upwind in the event of a chemical incident.)

Chemical and Biological Engineering Chemistry Building (CBEC) – 2ND Floor

IF THERE IS AN EVACUATION EMERGENCY:

- Assist persons with disabilities
- Exit the building using the nearest exit **DO NOT USE ELEVATORS!**
- Report to the nearest designated area.
- Call 911 (9-911 if on a campus phone)
- Call Public Safety at 605-394-6100
- Do not re-enter until authorized to do so.

CAMPUS ESCORT SERVICE:

Public Safety Provides Escort Services: To arrange an escort, call 605-394-6100, and a Public Safety Employee will escort you from any campus building to another.

Campus Emergency Numbers

Emergency 911 (9-911 from a campus phone)

SDSMT Public Safety (605)394-6100

Emergency Information Recording (605)394-2210



















SOUTH DAKOTA MINES

An engineering, science and technology university

Building Managers

Darren Schwede
Morgan Thomas-Abbott

KEY

-  You Are Here
-  Evacuation Route
-  Exit
-  Emergency Assembly Point
-  Restroom
-  Automated External Defibrillator
-  Fire Extinguisher
-  Fire Alarm (Pull Station)
-  Fire Alarm Control Panel
-  Fire Sprinkler Shut-off
-  Stand Pipe or FDC
-  Symbol of Accessibility
-  Tornado/Severe Thunderstorm Refuge Areas
-  First Aid Kit
-  Eye Wash/Safety Shower
-  Spill Kit

IF THERE IS AN EVACUATION EMERGENCY:

- Assist persons with disabilities
- Exit the building using the nearest exit **DO NOT USE ELEVATORS!**
- Report to the nearest designated area.
- Call 911 (9-911 if on a campus phone)
- Call Public Safety at 605-394-6100
- Do not re-enter until authorized to do so.

CAMPUS ESCORT SERVICE:

Public Safety Provides Escort Services: To arrange an escort, call 605-394-6100, and a Public Safety Employee will escort you from any campus building to another.

 Quad Area (Upwind in the event of a chemical incident.)

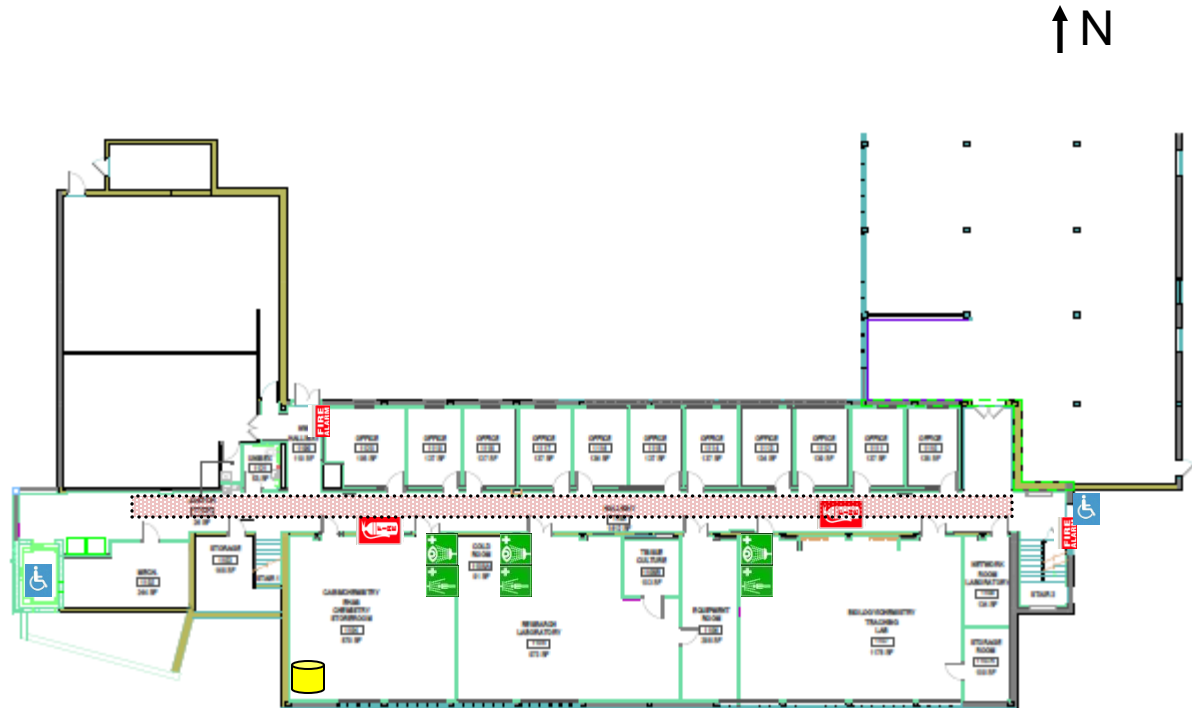

Chemical/Biological Engineering and Chemistry South– 1ST FLOOR

Campus Emergency Numbers

Emergency 911 (9-911 from a campus phone)

SDSMT Public Safety (605)394-6100

Emergency Information Recording (605)394-2210



SOUTH DAKOTA MINES

An engineering, science and technology university

Building Managers

Darren Schwede
Morgan Thomas-Abbott

KEY

- You Are Here
- Evacuation Route
- Exit
- Emergency Assembly Point
- Restroom
- Automated External Defibrillator
- Fire Extinguisher
- Fire Alarm (Pull Station)
- Fire Alarm Control Panel
- Fire Sprinkler Shut-off
- Stand Pipe or FDC
- Symbol of Accessibility
- Tornado/Severe Thunderstorm Refuge Areas
- First Aid Kit
- Eye Wash/Safety Shower
- Spill Kit

In the event of a tornado, please proceed to areas marked on the first floor map.

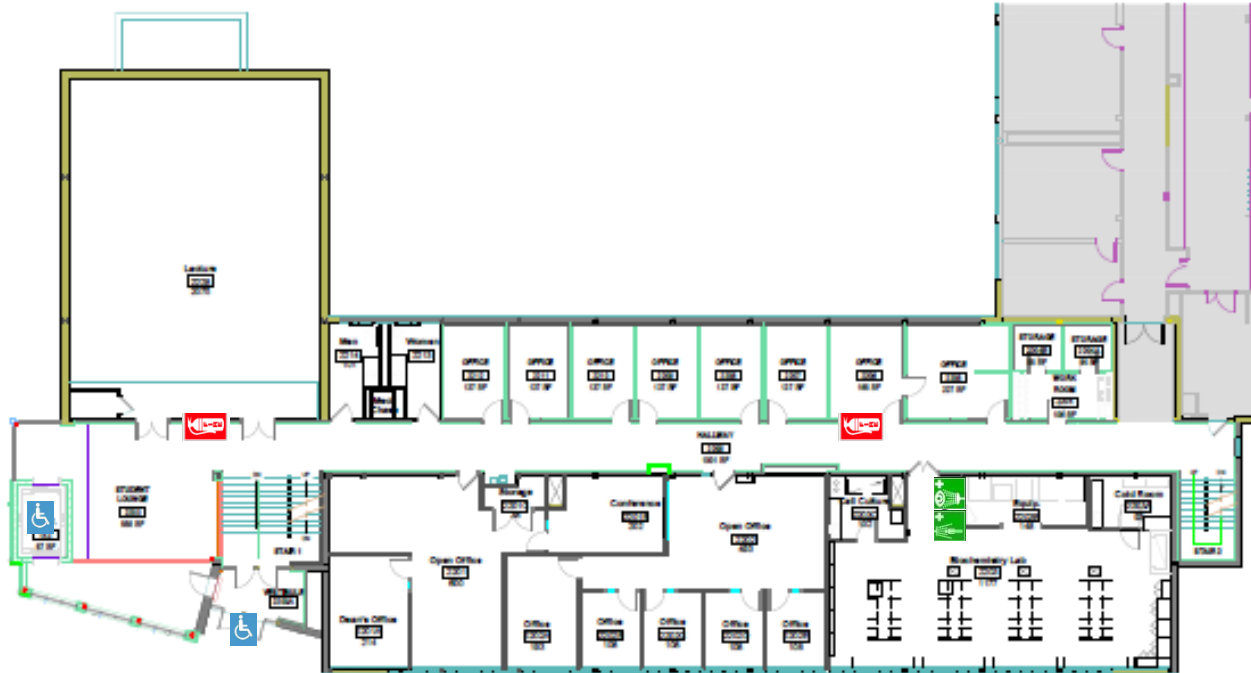

IF THERE IS AN EVACUATION EMERGENCY:

- Assist persons with disabilities
- Exit the building using the nearest exit **DO NOT USE ELEVATORS!**
- Report to the nearest designated area.
- Call 911 (9-911 if on a campus phone)
- Call Public Safety at 605-394-6100
- Do not re-enter until authorized to do so.

Quad Area (Upwind in the event of a chemical incident.)

CAMPUS ESCORT SERVICE:

Public Safety Provides Escort Services: To arrange an escort, call 605-394-6100, and a Public Safety Employee will escort you from any campus building to another.

Chemical/Biological Engineering and Chemistry South – 2ND FLOOR

Campus Emergency Numbers

Emergency 911 (9-911 from a campus phone)

SDSMT Public Safety (605)394-6100

Emergency Information Recording (605)394-2210



SOUTH DAKOTA MINES

An engineering, science and technology university

Building Managers

Darren Schwede
Morgan Thomas-Abbott

KEY

- You Are Here
- Evacuation Route
- Exit
- Emergency Assembly Point
- Restroom
- Automated External Defibrillator
- Fire Extinguisher
- Fire Alarm (Pull Station)
- Fire Alarm Control Panel
- Fire Sprinkler Shut-off
- Stand Pipe or FDC
- Symbol of Accessibility
- Tornado/Severe Thunderstorm
Refuge Areas
- First Aid Kit
- Eye Wash/Safety Shower
- Spill Kit

In the event of a tornado, please proceed to areas marked on the first floor map.

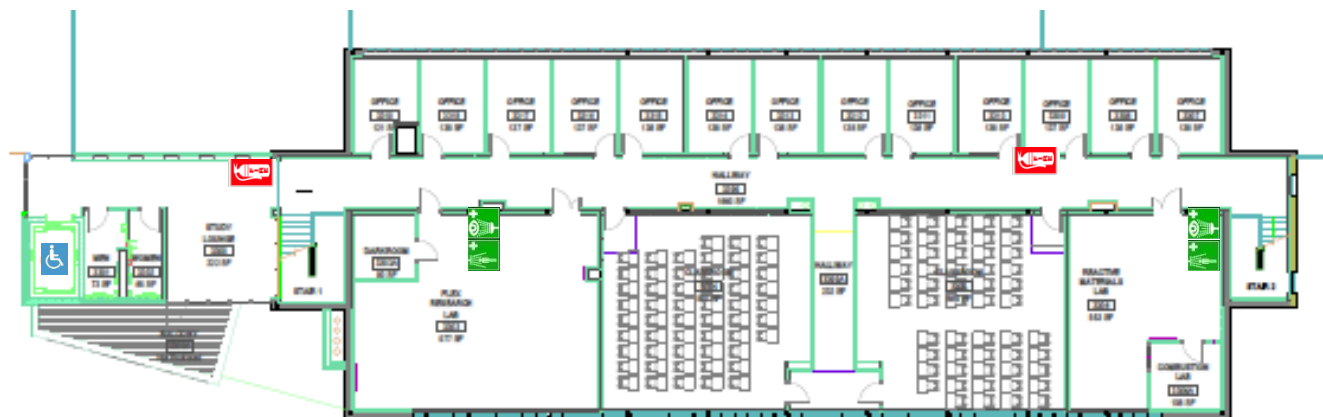

IF THERE IS AN EVACUATION EMERGENCY:

- Assist persons with disabilities
- Exit the building using the nearest exit **DO NOT USE ELEVATORS!**
- Report to the nearest designated area.
- Call 911 (9-911 if on a campus phone)
- Call Public Safety at 605-394-6100
- Do not re-enter until authorized to do so.

Quad Area (Upwind in the event of a chemical incident.)

CAMPUS ESCORT SERVICE:

Public Safety Provides Escort Services: To arrange an escort, call 605-394-6100, and a Public Safety Employee will escort you from any campus building to another.

Chemical/Biological Engineering and Chemistry South – 3RD FLOOR

Campus Emergency Numbers

Emergency 911 (9-911 from a campus phone)

SDSM&T Public Safety (605)394-6100

Emergency Information Recording (605)394-2210



SOUTH DAKOTA MINES

An engineering, science and technology university

Building Managers

Manny Siragusa

Leslee Moore

Ryan Koontz

KEY

- You Are Here
- Evacuation Route
- Exit
- Emergency Assembly Point
- Restroom
- Automated External Defibrillator
- Fire Extinguisher
- Fire Alarm (Pull Station)
- Fire Alarm Control Panel
- Fire Sprinkler Shut-off
- Stand Pipe or FDC
- Symbol of Accessibility
- Tornado/Severe Thunderstorm Refuge Areas
- First Aid Kit
- Eye Wash/Safety Shower
- Spill Kit



Flag Pole Across from O'Harra Building

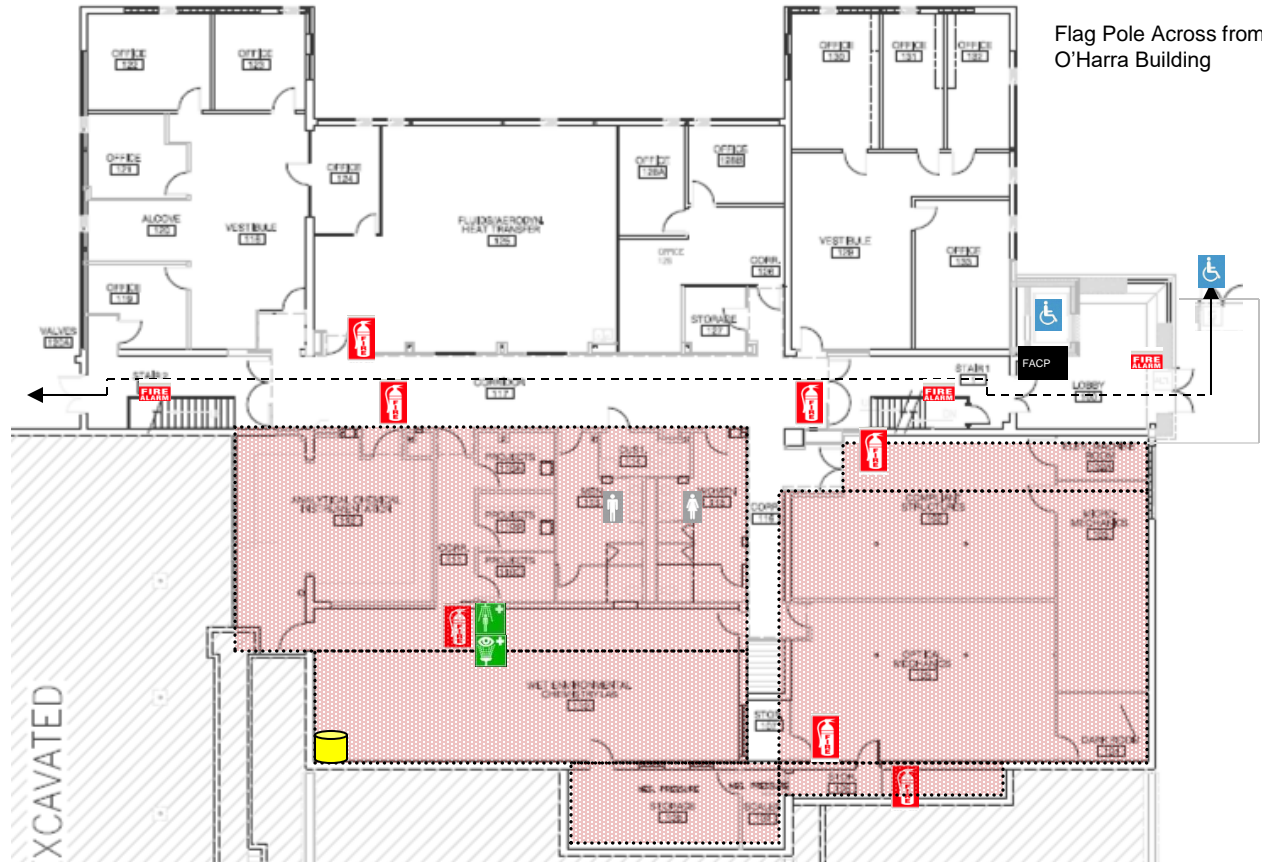

IF THERE IS AN EVACUATION EMERGENCY:

- Assist persons with disabilities
- Exit the building using the nearest exit **DO NOT USE ELEVATORS!**
- Report to the nearest designated area.
- Call 911 (9-911 if on a campus phone)
- Call Public Safety at 605-394-6100
- Do not re-enter until authorized to do so.

CAMPUS ESCORT SERVICE:

Public Safety Provides Escort Services: To arrange an escort, call 605-394-6100, and a Public Safety Employee will escort you from any campus building to another.

Civil/Mechanical – 1ST FLOOR

Campus Emergency Numbers

Emergency 911 (9-911 from a campus phone)

SDSMT Public Safety (605)394-6100

Emergency Information Recording (605)394-2210



SOUTH DAKOTA MINES

An engineering, science and technology university

Building Managers

Manny Siragusa

Leslee Moore

Ryan Koontz

KEY

- You Are Here
- Evacuation Route
- Exit
- Emergency Assembly Point
- Restroom
- Automated External Defibrillator
- Fire Extinguisher
- Fire Alarm (Pull Station)
- Fire Alarm Control Panel
- Fire Sprinkler Shut-off
- Stand Pipe or FDC
- Symbol of Accessibility
- Tornado/Severe Thunderstorm Refuge Areas
- First Aid Kit
- Eye Wash/Safety Shower
- Spill Kit

In the event of a tornado, please proceed to areas marked on the first floor map.



Flag Pole Across from O'Harra Building



Civil/Mechanical – 2ND FLOOR

IF THERE IS AN EVACUATION EMERGENCY:

- Assist persons with disabilities
- Exit the building using the nearest exit **DO NOT USE ELEVATORS!**
- Report to the nearest designated area.
- Call 911 (9-911 if on a campus phone)
- Call Public Safety at 605-394-6100
- Do not re-enter until authorized to do so.

CAMPUS ESCORT SERVICE:

Public Safety Provides Escort Services: To arrange an escort, call 605-394-6100, and a Public Safety Employee will escort you from any campus building to another.

Campus Emergency Numbers

Emergency 911 (9-911 from a campus phone)

SDSMT Public Safety (605)394-6100

Emergency Information Recording (605)394-2210



SOUTH DAKOTA MINES

An engineering, science and technology university

Building Managers

Manny Siragusa

Leslee Moore

Ryan Koontz

KEY

- You Are Here
- Evacuation Route
- Exit
- Emergency Assembly Point
- Restroom
- Automated External Defibrillator
- Fire Extinguisher
- Fire Alarm (Pull Station)
- Fire Alarm Control Panel
- Fire Sprinkler Shut-off
- Stand Pipe or FDC
- Symbol of Accessibility
- Tornado/Severe Thunderstorm
Refuge Areas
- First Aid Kit
- Eye Wash/Safety Shower
- Spill Kit

In the event of a tornado, please proceed to areas marked on the first floor map.



Flag Pole Across from
O'Harra Building

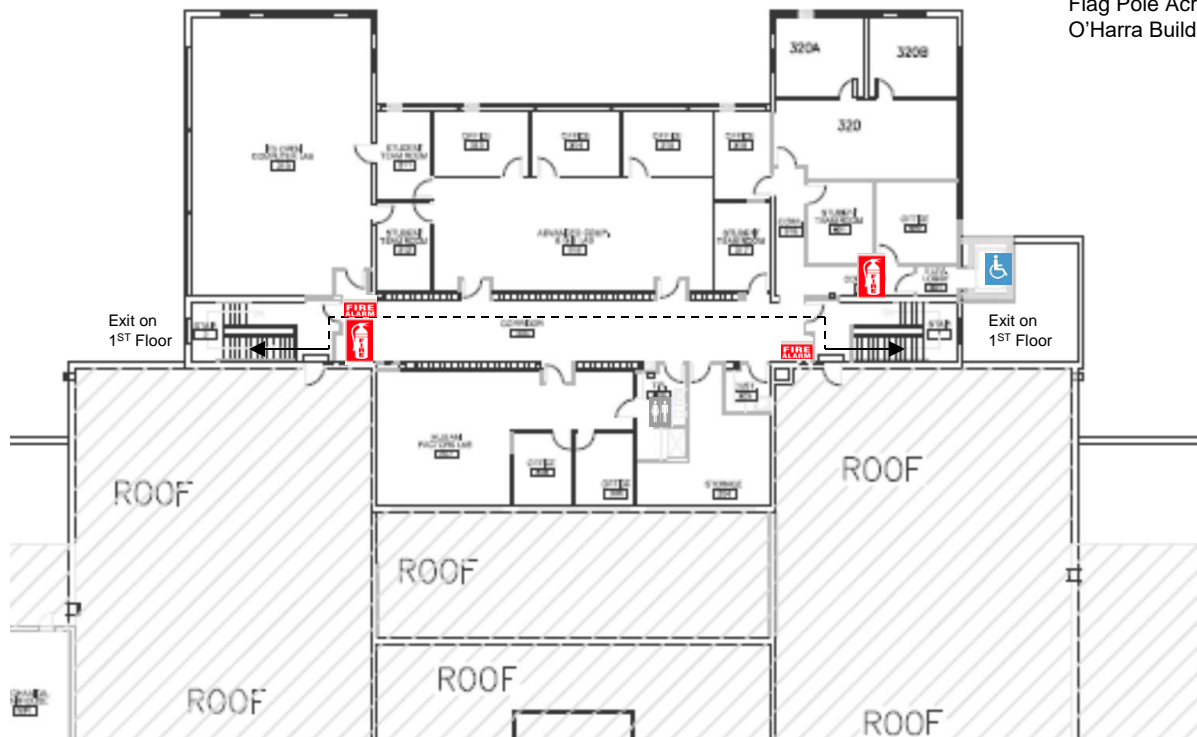

IF THERE IS AN EVACUATION EMERGENCY:

- Assist persons with disabilities
- Exit the building using the nearest exit **DO NOT USE ELEVATORS!**
- Report to the nearest designated area.
- Call 911 (9-911 if on a campus phone)
- Call Public Safety at 605-394-6100
- Do not re-enter until authorized to do so.

CAMPUS ESCORT SERVICE:

Public Safety Provides Escort Services: To arrange an escort, call 605-394-6100, and a Public Safety Employee will escort you from any campus building to another.

Civil/Mechanical – 3RD FLOOR

Campus Emergency Numbers

Emergency 911 (9-911 from a campus phone)

SDSMT Public Safety (605)394-6100

Emergency Information Recording (605)394-2210



SOUTH DAKOTA MINES

An engineering, science and technology university

Building Managers

Christy Tidwell
Margaret Smallbrock

KEY

- You Are Here
- Evacuation Route
- Exit
- Emergency Assembly Point
- Restroom
- Automated External Defibrillator
- Fire Extinguisher
- Fire Alarm (Pull Station)
- Fire Alarm Control Panel
- Fire Sprinkler Shut-off
- Stand Pipe or FDC
- Symbol of Accessibility
- Tornado/Severe Thunderstorm
Refuge Areas
- First Aid Kit
- Eye Wash/Safety Shower
- Spill Kit

IF THERE IS AN EVACUATION EMERGENCY:

- Assist persons with disabilities
- Exit the building using the nearest exit **DO NOT USE ELEVATORS!**
- Report to the nearest designated area.
- Call 911 (9-911 if on a campus phone)
- Call Public Safety at 605-394-6100
- Do not re-enter until authorized to do so.

CAMPUS ESCORT SERVICE:

Public Safety Provides Escort Services: To arrange an escort, call 605-394-6100, and a Public Safety Employee will escort you from any campus building to another.

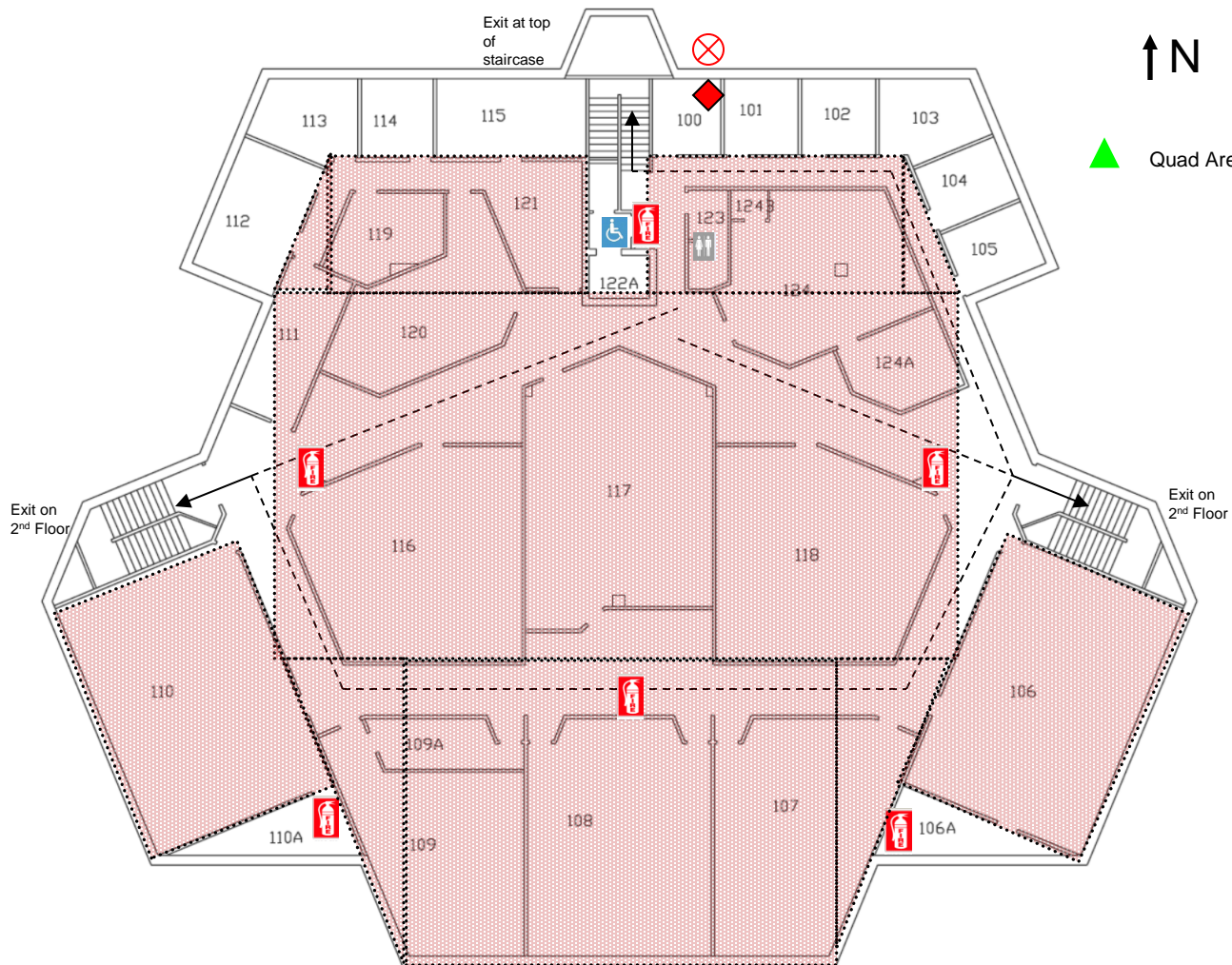

CLASSROOM BUILDING – 1st FLOOR

Campus Emergency Numbers

Emergency 911 (9-911 from a campus phone)

SDSMT Public Safety (605)394-6100

Emergency Information Recording (605)394-2210



SOUTH DAKOTA MINES

An engineering, science and technology university

Building Managers

Christy Tidwell
Margaret Smallbrock

KEY

- You Are Here
- Evacuation Route
- Exit
- Emergency Assembly Point
- Restroom
- AED
- Fire Extinguisher
- Fire Alarm (Pull Station)
- Fire Alarm Control Panel
- Fire Sprinkler Shut-off
- Stand Pipe or FDC
- Symbol of Accessibility
- Tornado/Severe Thunderstorm Refuge Areas
- First Aid Kit
- Eye Wash/Safety Shower
- Spill Kit

IF THERE IS AN EVACUATION EMERGENCY:

- Assist persons with disabilities
- Exit the building using the nearest exit **DO NOT USE ELEVATORS!**
- Report to the nearest designated area.
- Call 911 (9-911 if on a campus phone)
- Call Public Safety at 605-394-6100
- Do not re-enter until authorized to do so.

CAMPUS ESCORT SERVICE:

Public Safety Provides Escort Services: To arrange an escort, call 605-394-6100, and a Public Safety Employee will escort you from any campus building to another.

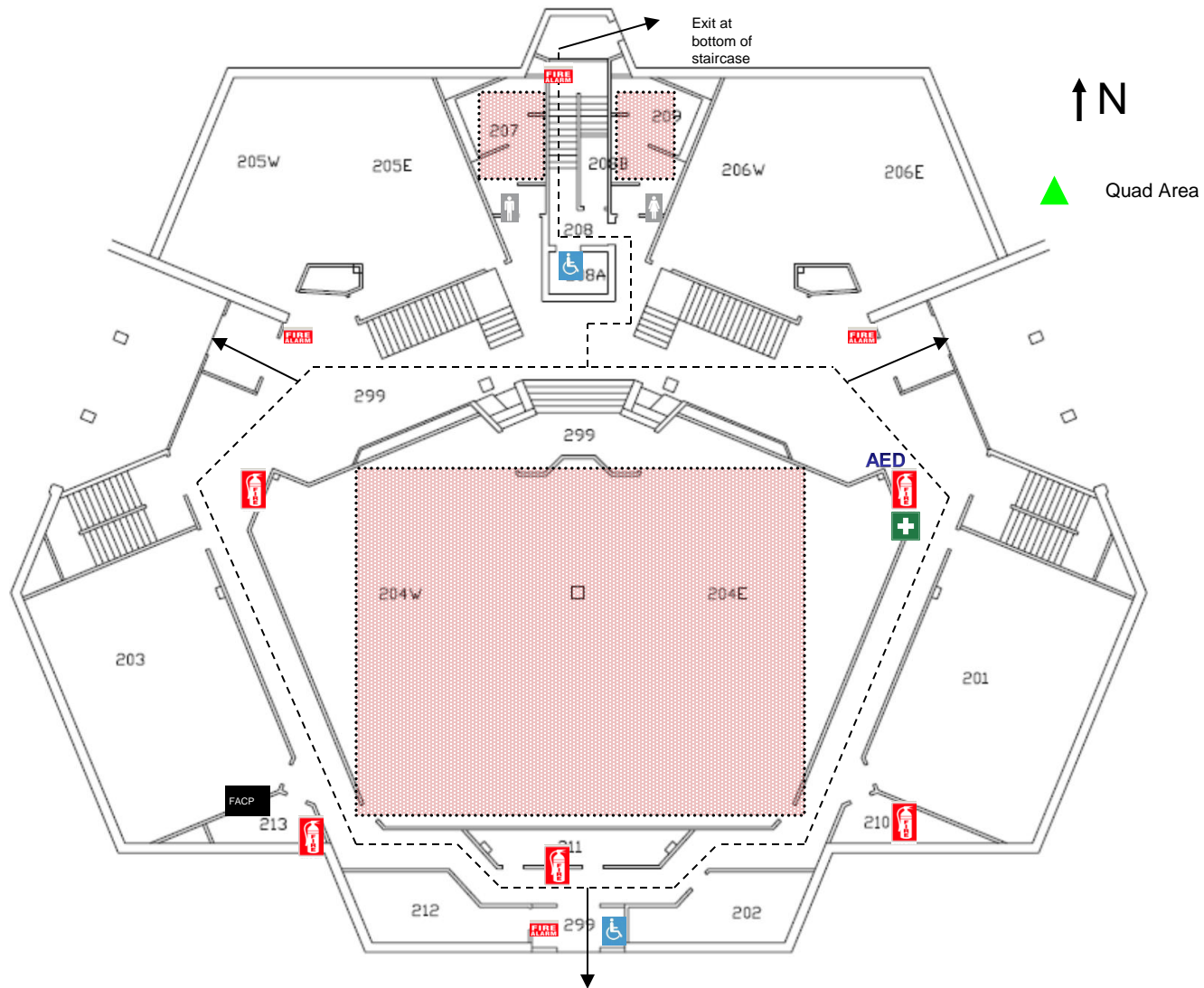

CLASSROOM BUILDING – 2nd FLOOR

Campus Emergency Numbers

Emergency 911 (9-911 from a campus phone)

SDSMT Public Safety (605)394-6100

Emergency Information Recording (605)394-2210



SOUTH DAKOTA MINES

An engineering, science and technology university

Building Managers

Christy Tidwell
Margaret Smallbrock

KEY

- You Are Here
- Evacuation Route
- Exit
- Emergency Assembly Point
- Restroom
- Automated External Defibrillator
- Fire Extinguisher
- Fire Alarm (Pull Station)
- Fire Alarm Control Panel
- Fire Sprinkler Shut-off
- Stand Pipe or FDC
- Symbol of Accessibility
- Tornado/Severe Thunderstorm Refuge Areas
- First Aid Kit
- Eye Wash/Safety Shower
- Spill Kit

In the event of a tornado, please proceed to areas marked on the first and second floor maps.

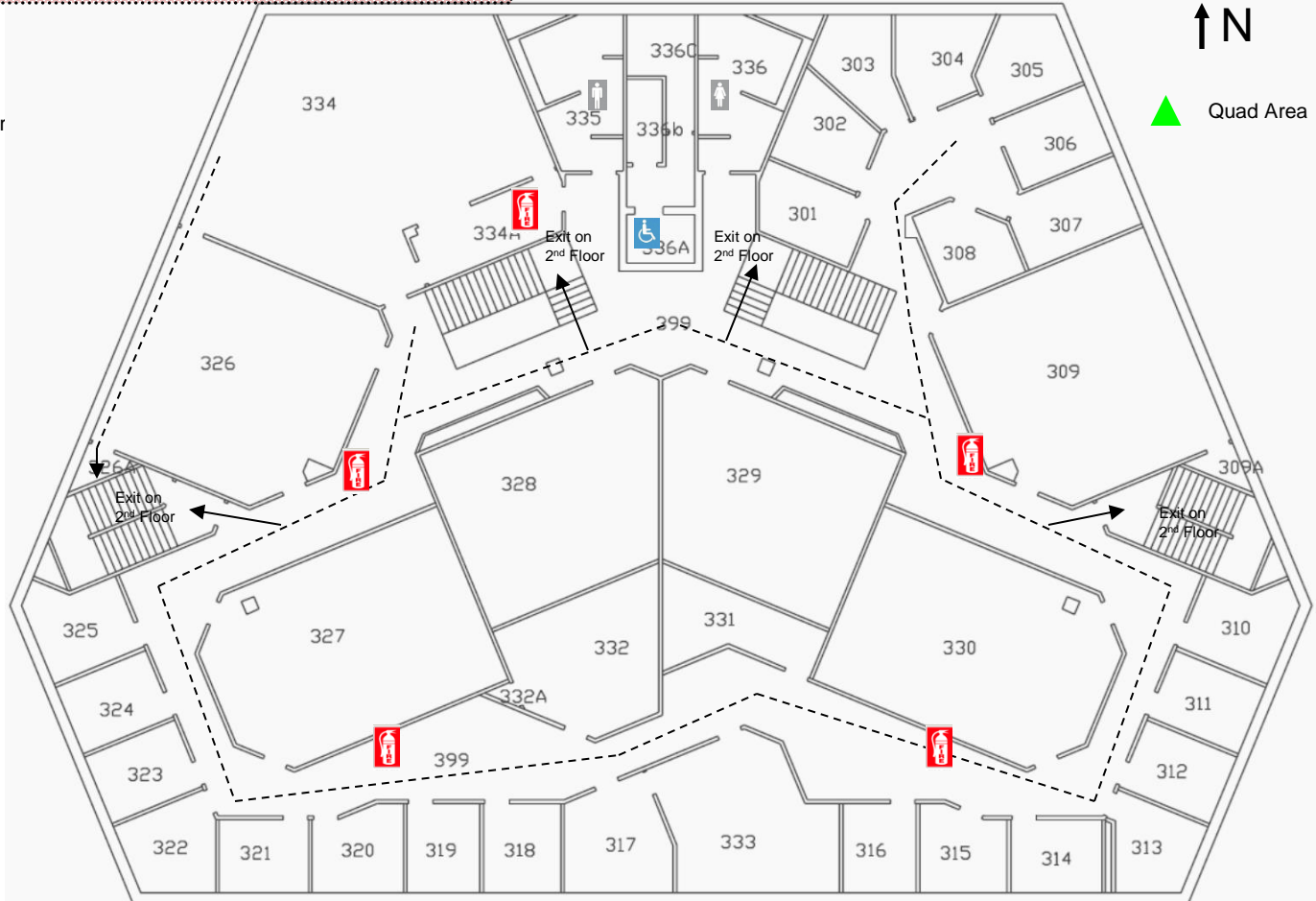

IF THERE IS AN EVACUATION EMERGENCY:

- Assist persons with disabilities
- Exit the building using the nearest exit **DO NOT USE ELEVATORS!**
- Report to the nearest designated area.
- Call 911 (9-911 if on a campus phone)
- Call Public Safety at 605-394-6100
- Do not re-enter until authorized to do so.

CAMPUS ESCORT SERVICE:

Public Safety Provides Escort Services: To arrange an escort, call 605-394-6100, and a Public Safety Employee will escort you from any campus building to another.

CLASSROOM BUILDING – 3rd FLOOR

Campus Emergency Numbers

Emergency 911 (9-911 from a campus phone)

SDSMT Public Safety (605)394-6100

Emergency Information Recording (605)394-2210



SOUTH DAKOTA MINES

An engineering, science and technology university

Building Managers

Manny Siragusa
Leslee Moore
Ryan Koontz

KEY

- You Are Here
- Evacuation Route
- Exit
- Emergency Assembly Point
- Restroom
- Automated External Defibrillator
- Fire Extinguisher
- Fire Alarm (Pull Station)
- Fire Alarm Control Panel
- Fire Sprinkler Shut-off
- Stand Pipe or FDC
- Symbol of Accessibility
- Tornado/Severe Thunderstorm Refuge Areas
- First Aid Kit
- Eye Wash/Safety Shower
- Spill Kit

IF THERE IS AN EVACUATION EMERGENCY:

- Assist persons with disabilities
- Exit the building using the nearest exit **DO NOT USE ELEVATORS!**
- Report to the nearest designated area.
- Call 911 (9-911 if on a campus phone)
- Call Public Safety at 605-394-6100
- Do not re-enter until authorized to do so.

CAMPUS ESCORT SERVICE:

Public Safety Provides Escort Services: To arrange an escort, call 605-394-6100, and a Public Safety Employee will escort you from any campus building to another.



Flag Pole Across from O'Harra Building

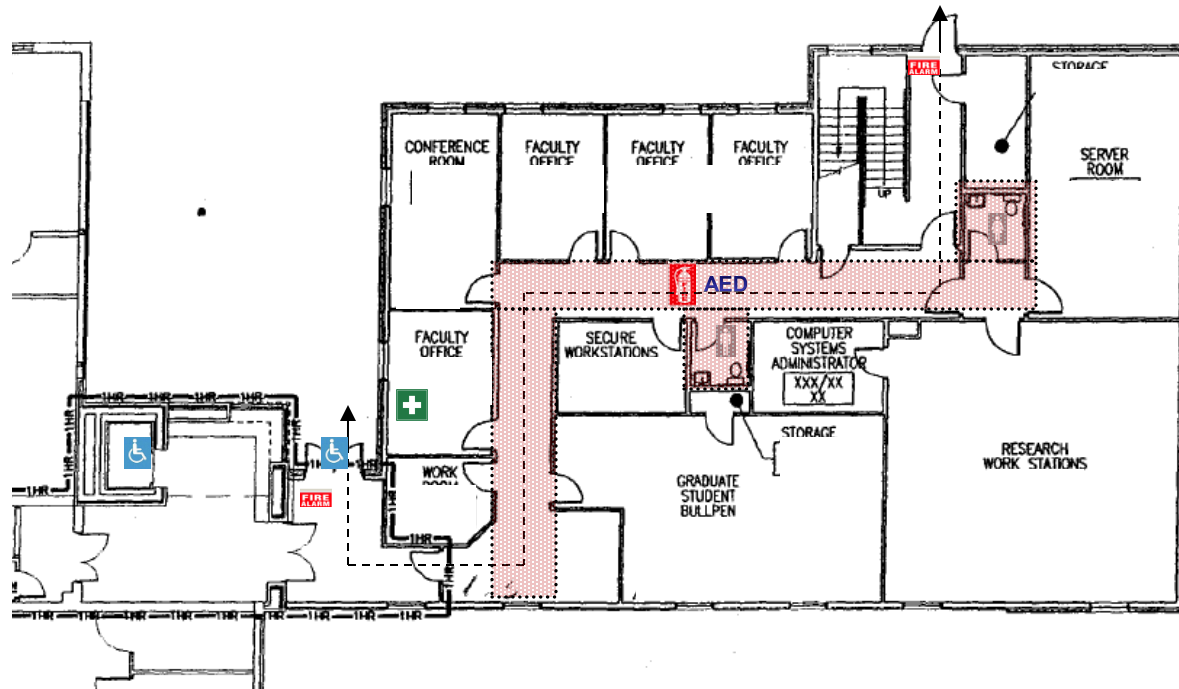

Computational Mechanics - 1st Floor

Campus Emergency Numbers

Emergency 911 (9-911 from a campus phone)

SDSMT Public Safety (605)394-6100

Emergency Information Recording (605)394-2210



SOUTH DAKOTA MINES

An engineering, science and technology university

Building Managers

Manny Siragusa
Leslee Moore
Ryan Koontz

KEY

- You Are Here
- Evacuation Route
- Exit
- Emergency Assembly Point
- Restroom
- Automated External Defibrillator
- Fire Extinguisher
- Fire Alarm (Pull Station)
- Fire Alarm Control Panel
- Fire Sprinkler Shut-off
- Stand Pipe or FDC
- Symbol of Accessibility
- Tornado/Severe Thunderstorm Refuge Areas
- First Aid Kit
- Eye Wash/Safety Shower
- Spill Kit

In the event of a tornado, please proceed to areas marked on the first floor map.

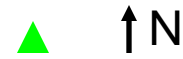

Flag Pole Across from O'Harra Building

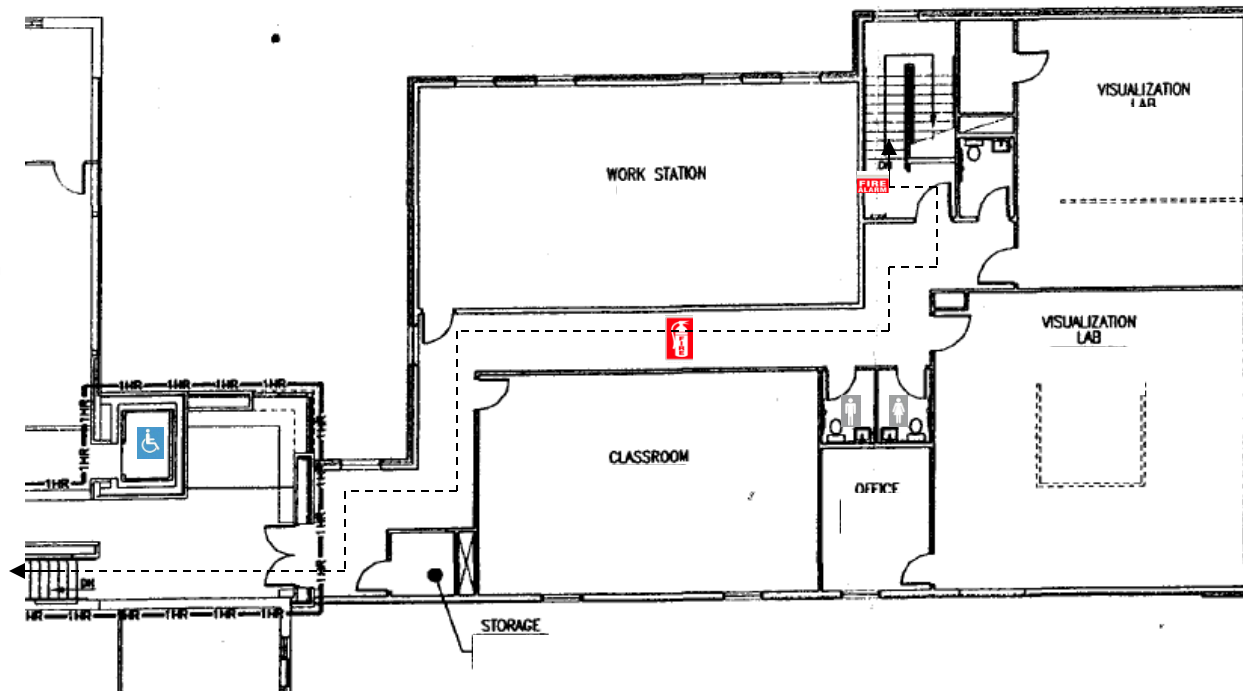

IF THERE IS AN EVACUATION EMERGENCY:

- Assist persons with disabilities
- Exit the building using the nearest exit DO NOT USE ELEVATORS!
- Report to the nearest designated area.
- Call 911 (9-911 if on a campus phone)
- Call Public Safety at 605-394-6100
- Do not re-enter until authorized to do so.

CAMPUS ESCORT SERVICE:

Public Safety Provides Escort Services: To arrange an escort, call 605-394-6100, and a Public Safety Employee will escort you from any campus building to another.

Computational Mechanics - 2nd Floor

Campus Emergency Numbers

Emergency 911 (9-911 from a campus phone)

SDSM&T Public Safety (605)394-6100

Emergency Information Recording (605)394-2210



SOUTH DAKOTA MINES

An engineering, science and technology university

Building Managers

Katie Wahls
Bryce Nussbaum

KEY

- You Are Here
- Evacuation Route
- Exit
- Emergency Assembly Point
- Restroom
- Automated External Defibrillator
- Fire Extinguisher
- Fire Alarm (Pull Station)
- Fire Alarm Control Panel
- Fire Sprinkler Shut-off
- Stand Pipe or FDC
- Symbol of Accessibility
- Tornado/Severe Thunderstorm Refuge Areas
- First Aid Kit
- Eye Wash/Safety Shower
- Spill Kit

The Emergency Assembly Points are located in the March/Dake Plaza and the Civil/Mechanical courtyard area.

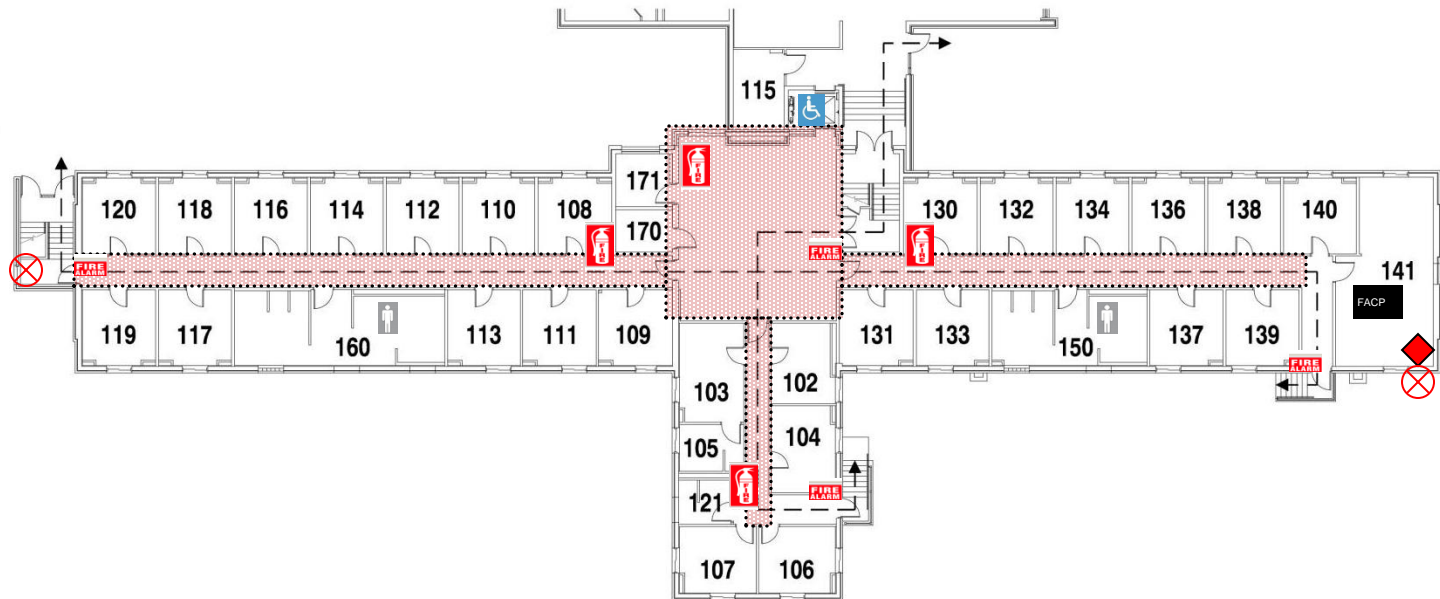

IF THERE IS AN EVACUATION EMERGENCY:

- Assist persons with disabilities
- Exit the building using the nearest exit **DO NOT USE ELEVATORS!**
- Report to the nearest designated area.
- Call 911 (9-911 if on a campus phone)
- Call Public Safety at 605-394-6100
- Do not re-enter until authorized to do so.

CAMPUS ESCORT SERVICE:

Public Safety Provides Escort Services: To arrange an escort, call 605-394-6100, and a Public Safety Employee will escort you from any campus building to another.

CONNOLLY HALL – 1st FLOOR

Campus Emergency Numbers

Emergency 911 (9-911 from a campus phone)

SDSM&T Public Safety (605)394-6100

Emergency Information Recording (605)394-2210



















SOUTH DAKOTA MINES

An engineering, science and technology university

Building Managers

Katie Wahls
Bryce Nussbaum

KEY

-  You Are Here
-  Evacuation Route
-  Exit
-  Emergency Assembly Point
-  Restroom
-  Automated External Defibrillator
-  Fire Extinguisher
-  Fire Alarm (Pull Station)
-  Fire Alarm Control Panel
-  Fire Sprinkler Shut-off
-  Stand Pipe or FDC
-  Symbol of Accessibility
-  Tornado/Severe Thunderstorm Refuge Areas
-  First Aid Kit
-  Eye Wash/Safety Shower
-  Spill Kit



The Emergency Assembly Points are located in the March/Dake Plaza and the Civil/Mechanical courtyard area.

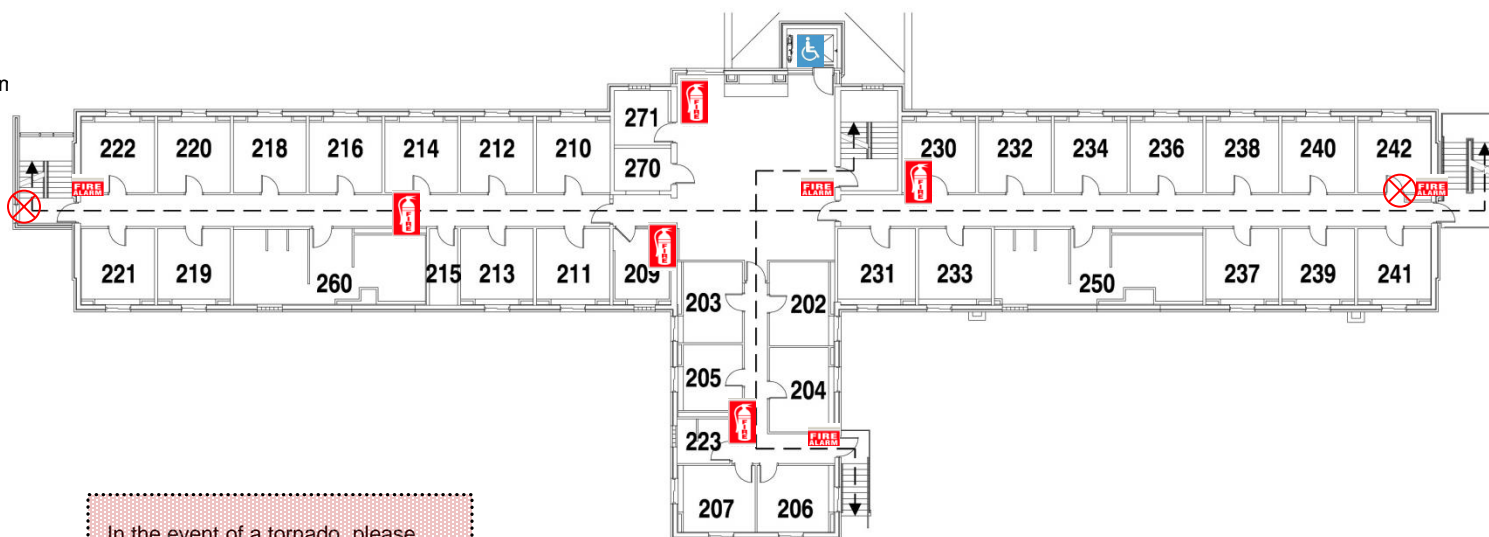

In the event of a tornado, please proceed to areas marked on the first floor map.

IF THERE IS AN EVACUATION EMERGENCY:

- Assist persons with disabilities
- Exit the building using the nearest exit **DO NOT USE ELEVATORS!**
- Report to the nearest designated area.
- Call 911 (9-911 if on a campus phone)
- Call Public Safety at 605-394-6100
- Do not re-enter until authorized to do so.

CAMPUS ESCORT SERVICE:

Public Safety Provides Escort Services: To arrange an escort, call 605-394-6100, and a Public Safety Employee will escort you from any campus building to another.

CONNOLLY HALL – 2nd FLOOR

Campus Emergency Numbers

Emergency 911 (9-911 from a campus phone)

SDSM&T Public Safety (605)394-6100

Emergency Information Recording (605)394-2210



















SOUTH DAKOTA MINES

An engineering, science and technology university

Building Managers

Katie Wahls
Bryce Nussbaum

KEY

-  You Are Here
-  Evacuation Route
-  Exit
-  Emergency Assembly Point
-  Restroom
-  Automated External Defibrillator
-  Fire Extinguisher
-  Fire Alarm (Pull Station)
-  Fire Alarm Control Panel
-  Fire Sprinkler Shut-off
-  Stand Pipe or FDC
-  Symbol of Accessibility
-  Tornado/Severe Thunderstorm Refuge Areas
-  First Aid Kit
-  Eye Wash/Safety Shower
-  Spill Kit

 The Emergency Assembly Points are located in the March/Dake Plaza and the Civil/Mechanical courtyard area.



In the event of a tornado, please proceed to areas marked on the first floor map.

IF THERE IS AN EVACUATION EMERGENCY:

- Assist persons with disabilities
- Exit the building using the nearest exit **DO NOT USE ELEVATORS!**
- Report to the nearest designated area.
- Call 911 (9-911 if on a campus phone)
- Call Public Safety at 605-394-6100
- Do not re-enter until authorized to do so.

CAMPUS ESCORT SERVICE:

Public Safety Provides Escort Services: To arrange an escort, call 605-394-6100, and a Public Safety Employee will escort you from any campus building to another.

CONNOLLY HALL— 3rd FLOOR

Campus Emergency Numbers

Emergency 911 (9-911 from a campus phone)

SDSMT Public Safety (605)394-6100

Emergency Information Recording (605)394-2210



















SOUTH DAKOTA MINES

An engineering, science and technology university

Building Managers

Brad O'Brien, Jason Erickson
Connie Krosschell, Jen Dusek

KEY

-  You Are Here
-  Evacuation Route
-  Exit
-  Emergency Assembly Point
-  Restroom
-  Automated External Defibrillator
-  Fire Extinguisher
-  Fire Alarm (Pull Station)  Quad Area
-  Fire Alarm Control Panel
-  Fire Sprinkler Shut-off
-  Stand Pipe or FDC
-  Symbol of Accessibility
-  Tornado/Severe Thunderstorm Refuge Areas
-  First Aid Kit
-  Eye Wash/Safety Shower
-  Spill Kit

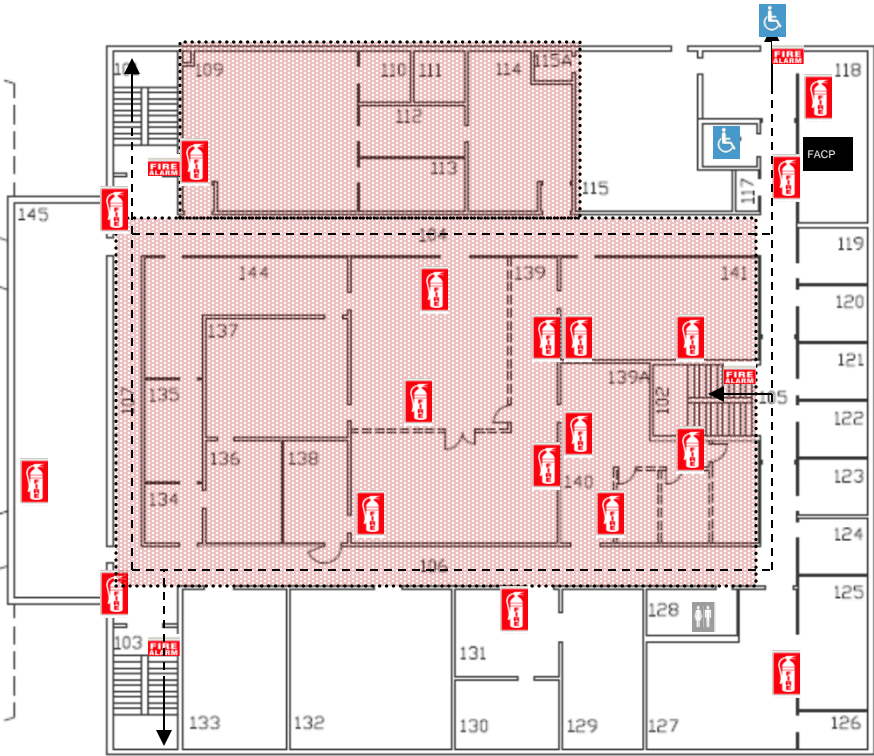
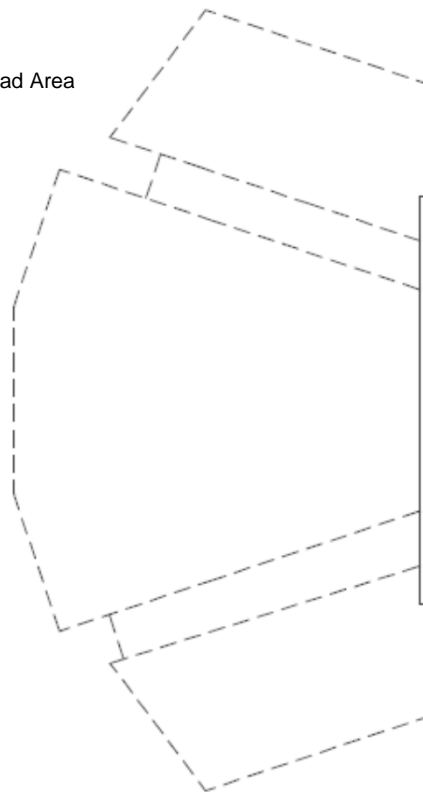

IF THERE IS AN EVACUATION EMERGENCY:

- Assist persons with disabilities
- Exit the building using the nearest exit **DO NOT USE ELEVATORS!**
- Report to the nearest designated area.
- Call 911 (9-911 if on a campus phone)
- Call Public Safety at 605-394-6100
- Do not re-enter until authorized to do so.

CAMPUS ESCORT SERVICE:

Public Safety Provides Escort Services: To arrange an escort, call 605-394-6100, and a Public Safety Employee will escort you from any campus building to another.

ELECTRICAL ENGINEERING/PHYSICS – 1ST FLOOR

Campus Emergency Numbers

Emergency 911 (9-911 from a campus phone)

SDSMT Public Safety (605)394-6100

Emergency Information Recording (605)394-2210



SOUTH DAKOTA MINES

An engineering, science and technology university

Building Managers

Brad O'Brien, Jason Erickson
Connie Krosschell, Jen Dusek

KEY

- You Are Here
- Evacuation Route
- Exit
- Emergency Assembly Point
- Restroom
- Automated External Defibrillator
- Fire Extinguisher
- Fire Alarm (Pull Station)
- Fire Alarm Control Panel
- Fire Sprinkler Shut-off
- Stand Pipe or FDC
- Symbol of Accessibility
- Tornado/Severe Thunderstorm
Refuge Areas
- First Aid Kit
- Eye Wash/Safety Shower
- Spill Kit

In the event of a tornado, please proceed to areas marked on the first floor map.

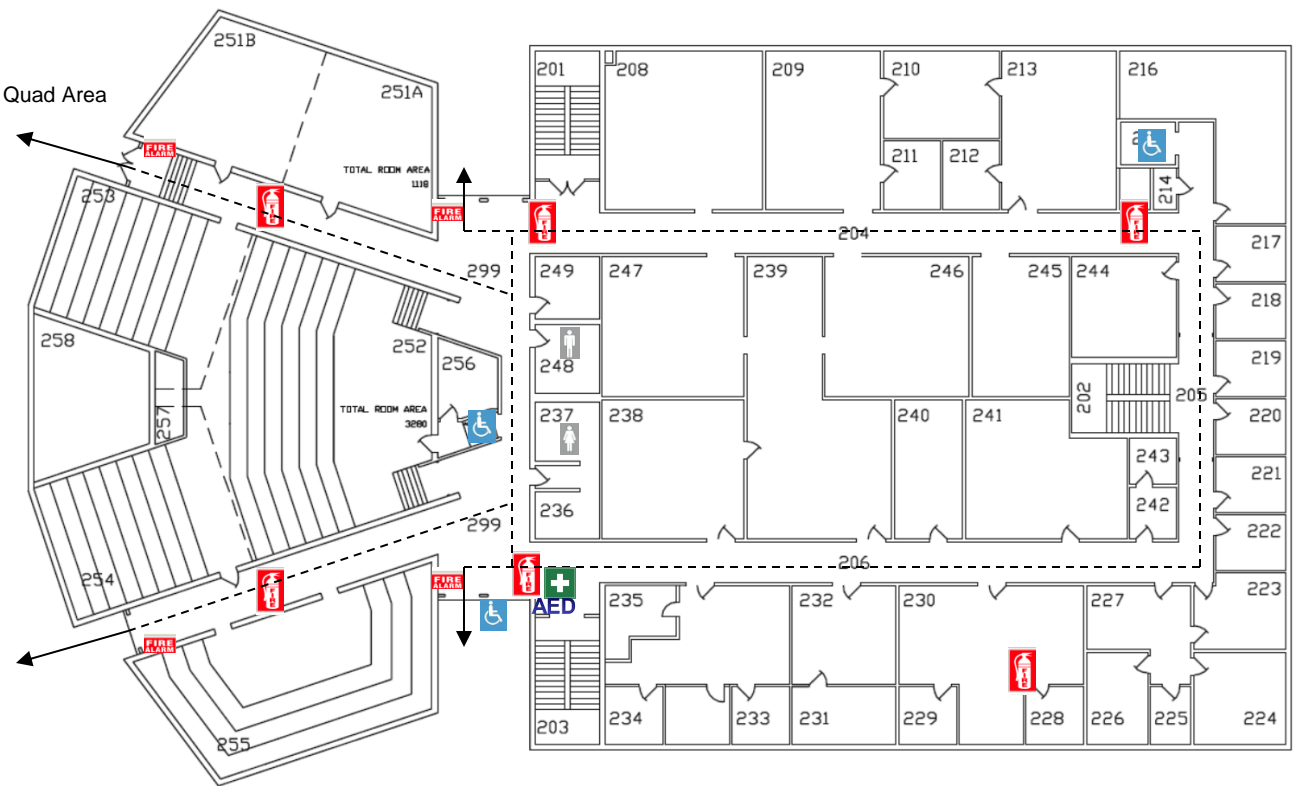

IF THERE IS AN EVACUATION EMERGENCY:

- Assist persons with disabilities
- Exit the building using the nearest exit **DO NOT USE ELEVATORS!**
- Report to the nearest designated area.
- Call 911 (9-911 if on a campus phone)
- Call Public Safety at 605-394-6100
- Do not re-enter until authorized to do so.

CAMPUS ESCORT SERVICE:

Public Safety Provides Escort Services: To arrange an escort, call 605-394-6100, and a Public Safety Employee will escort you from any campus building to another.

ELECTRICAL ENGINEERING/PHYSICS – 2ND FLOOR

Campus Emergency Numbers

Emergency 911 (9-911 from a campus phone)

SDSMT Public Safety (605)394-6100

Emergency Information Recording (605)394-2210



SOUTH DAKOTA MINES

An engineering, science and technology university

Building Managers

Brad O'Brien, Jason Erickson
Connie Krosschell, Jen Dusek

KEY

- You Are Here
- Evacuation Route
- Exit
- Emergency Assembly Point
- Restroom
- Automated External Defibrillator
- Fire Extinguisher
- Fire Alarm (Pull Station)
- Fire Alarm Control Panel
- Fire Sprinkler Shut-off
- Stand Pipe or FDC
- Symbol of Accessibility
- Tornado/Severe Thunderstorm
Refuge Areas
- First Aid Kit
- Eye Wash/Safety Shower
- Spill Kit

In the event of a tornado, please proceed to areas marked on the first floor map.

Quad Area

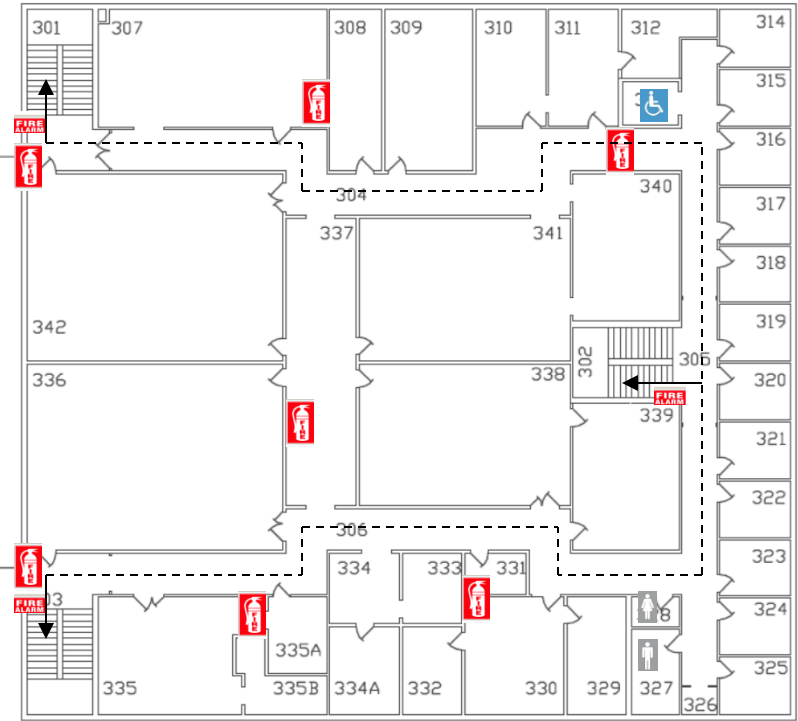
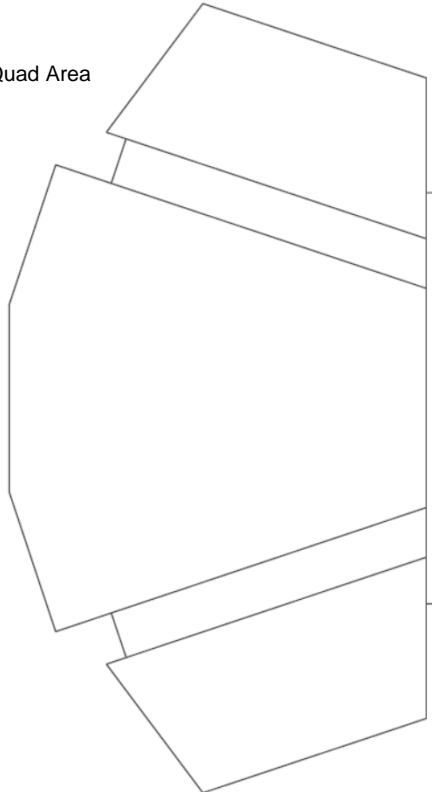

IF THERE IS AN EVACUATION EMERGENCY:

- Assist persons with disabilities
- Exit the building using the nearest exit DO NOT USE ELEVATORS!
- Report to the nearest designated area.
- Call 911 (9-911 if on a campus phone)
- Call Public Safety at 605-394-6100
- Do not re-enter until authorized to do so.

CAMPUS ESCORT SERVICE:

Public Safety Provides Escort Services: To arrange an escort, call 605-394-6100, and a Public Safety Employee will escort you from any campus building to another.

ELECTRICAL ENGINEERING/PHYSICS – 3RD FLOOR

Campus Emergency Numbers

Emergency 911 (9-911 from a campus phone)

SDSMT Public Safety (605)394-6100

Emergency Information Recording (605)394-2210



SOUTH DAKOTA MINES

An engineering, science and technology university

Building Managers

Catherine Helgeson
Margaret Smallbrock

KEY

- You Are Here
- Evacuation Route
- Exit
- Emergency Assembly Point
- Restroom
- Automated External Defibrillator
- Fire Extinguisher
- Fire Alarm (Pull Station)
- Fire Alarm Control Panel
- Fire Sprinkler Shut-off
- Stand Pipe or FDC
- Symbol of Accessibility
- Tornado/Severe Thunderstorm Refuge Areas
- First Aid Kit
- Eye Wash/Safety Shower
- Spill Kit

IF THERE IS AN EVACUATION EMERGENCY:

- Assist persons with disabilities
- Exit the building using the nearest exit **DO NOT USE ELEVATORS!**
- Report to the nearest designated area.
- Call 911 (9-911 if on a campus phone)
- Call Public Safety at 605-394-6100
- Do not re-enter until authorized to do so.

CAMPUS ESCORT SERVICE:

Public Safety Provides Escort Services: To arrange an escort, call 605-394-6100, and a Public Safety Employee will escort you from any campus building to another.

In the event of a tornado, take shelter in the shop area away from windows and equipment.

South Parking Lot

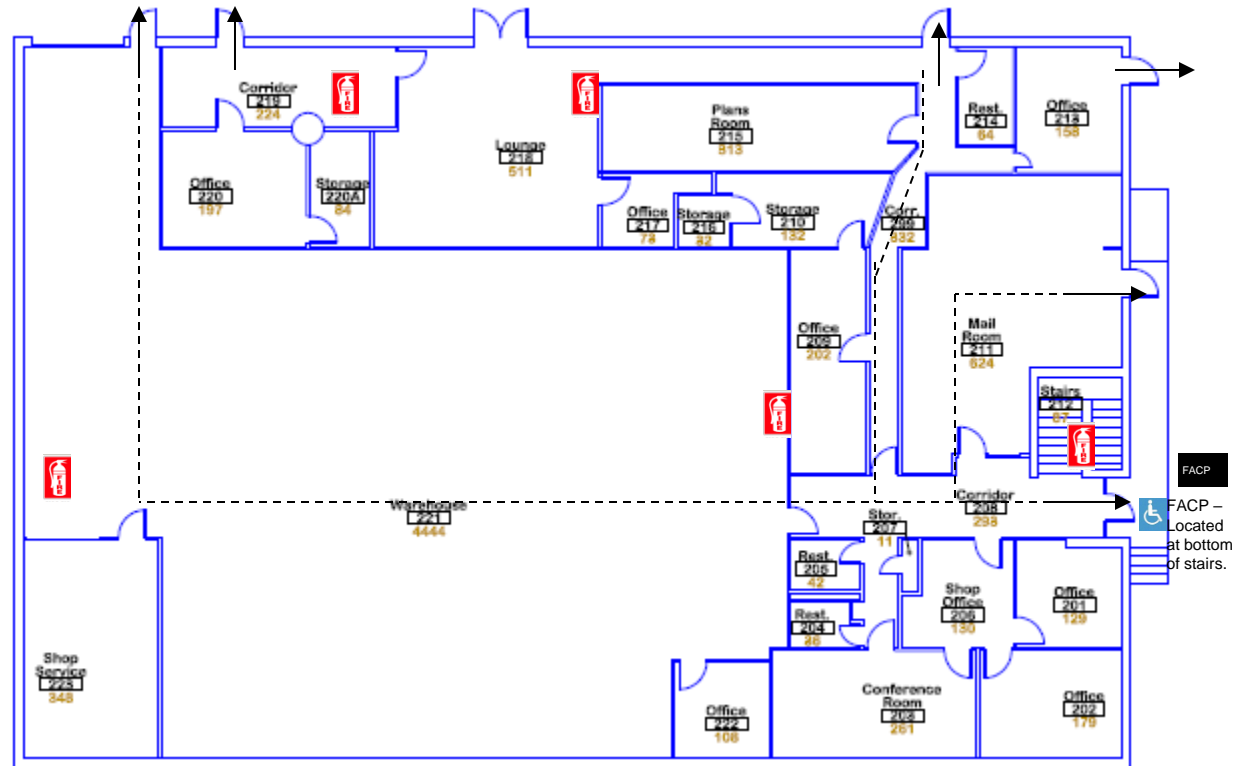

First aid kit located in shop area on first floor.

Facility Services— 1st Floor

Campus Emergency Numbers

Emergency 911 (9-911 from a campus phone)

SDSMT Public Safety (605)394-6100

Emergency Information Recording (605)394-2210



SOUTH DAKOTA MINES

An engineering, science and technology university

Building Managers

Katie Wahls
Bryce Nussbaum

KEY

- You Are Here
- Evacuation Route
- Exit
- Emergency Assembly Point
- Restroom
- Automated External Defibrillator
- Fire Extinguisher
- Fire Alarm (Pull Station)
- Fire Alarm Control Panel
- Fire Sprinkler Shut-off
- Stand Pipe or FDC
- Symbol of Accessibility
- Tornado/Severe Thunderstorm Refuge Areas
- First Aid Kit
- Eye Wash/Safety Shower
- Spill Kit

The Emergency Assembly Point is located in the March/Dake Plaza.

The main Fire Alarm Control Panel is located at the West Surbeck Center entrance.

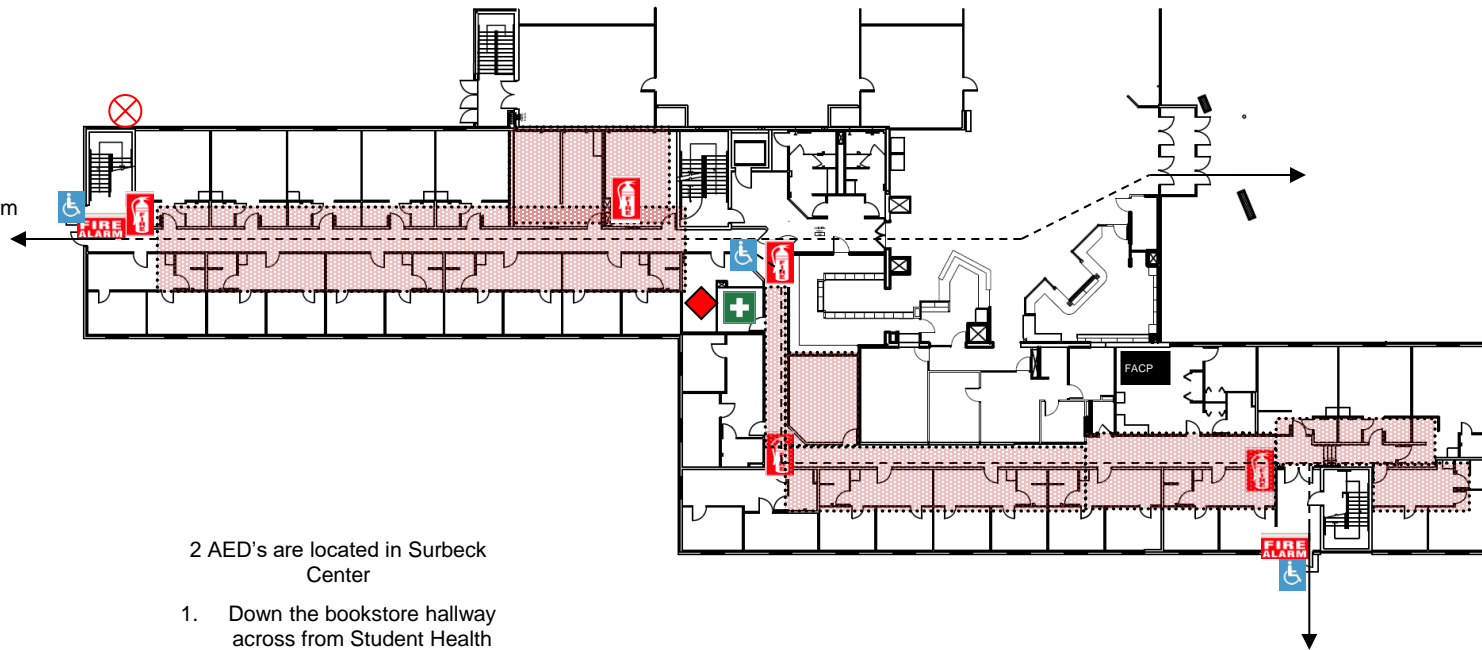

IF THERE IS AN EVACUATION EMERGENCY:

- Assist persons with disabilities
- Exit the building using the nearest exit DO NOT USE ELEVATORS!
- Report to the nearest designated area.
- Call 911 (9-911 if on a campus phone)
- Call Public Safety at 605-394-6100
- Do not re-enter until authorized to do so.

2 AED's are located in Surbeck Center

1. Down the bookstore hallway across from Student Health
2. Across from the Dining Services Office

CAMPUS ESCORT SERVICE:

Public Safety Provides Escort Services: To arrange an escort, call 605-394-6100, and a Public Safety Employee will escort you from any campus building to another.

HOWARD PETERSON HALL – 1ST FLOOR

Campus Emergency Numbers

Emergency 911 (9-911 from a campus phone)

SDSMT Public Safety (605)394-6100

Emergency Information Recording (605)394-2210



SOUTH DAKOTA MINES

An engineering, science and technology university

Building Managers

Katie Wahls
Bryce Nussbaum

KEY

- You Are Here
- Evacuation Route
- Exit
- Emergency Assembly Point
- Restroom
- Automated External Defibrillator
- Fire Extinguisher
- Fire Alarm (Pull Station)
- Fire Alarm Control Panel
- Fire Sprinkler Shut-off
- Stand Pipe or FDC
- Symbol of Accessibility
- Tornado/Severe Thunderstorm Refuge Areas
- First Aid Kit
- Eye Wash/Safety Shower
- Spill Kit

The Emergency Assembly Point is located in the March/Dake Plaza.

In the event of a tornado, please proceed to areas marked on the first floor map.

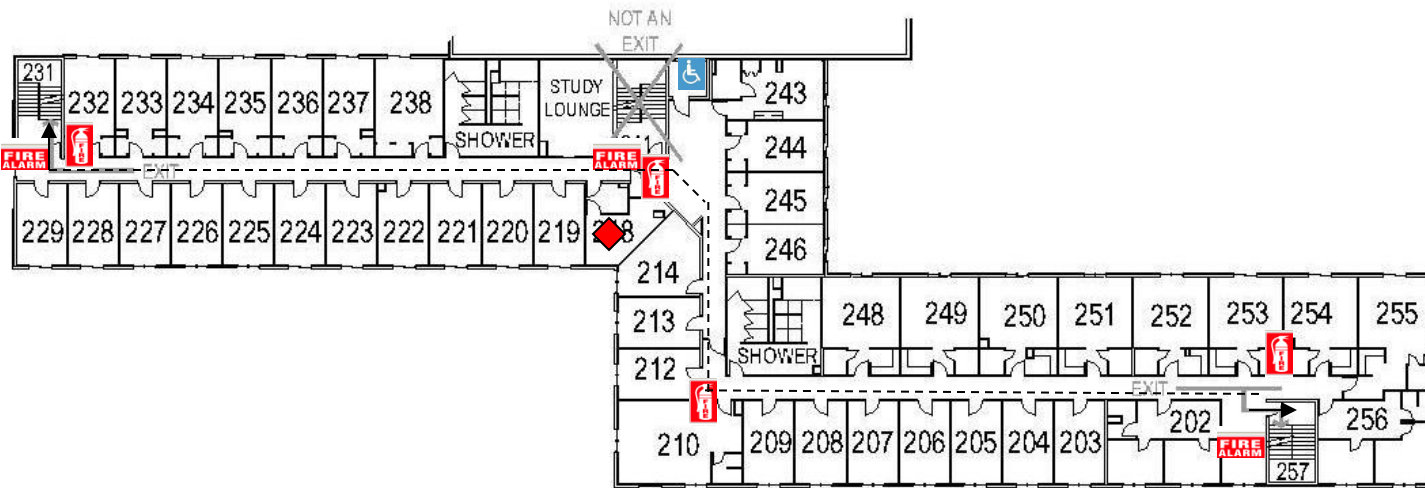

IF THERE IS AN EVACUATION EMERGENCY:

- Assist persons with disabilities
- Exit the building using the nearest exit **DO NOT USE ELEVATORS!**
- Report to the nearest designated area.
- Call 911 (9-911 if on a campus phone)
- Call Public Safety at 605-394-6100
- Do not re-enter until authorized to do so.

CAMPUS ESCORT SERVICE:

Public Safety Provides Escort Services: To arrange an escort, call 605-394-6100, and a Public Safety Employee will escort you from any campus building to another.

HOWARD PETERSON HALL – 2ND FLOOR

Campus Emergency Numbers

Emergency 911 (9-911 from a campus phone)

SDSMT Public Safety (605)394-6100

Emergency Information Recording (605)394-2210



SOUTH DAKOTA MINES

An engineering, science and technology university

Building Managers

Katie Wahls
Bryce Nussbaum



KEY

- You Are Here
- Evacuation Route
- Exit
- Emergency Assembly Point
- Restroom
- Automated External Defibrillator
- Fire Extinguisher
- Fire Alarm (Pull Station)
- Fire Alarm Control Panel
- Fire Sprinkler Shut-off
- Stand Pipe or FDC
- Symbol of Accessibility
- Tornado/Severe Thunderstorm Refuge Areas
- First Aid Kit
- Eye Wash/Safety Shower
- Spill Kit

The Emergency Assembly Point is located in the March/Dake Plaza.

In the event of a tornado, please proceed to areas marked on the first floor map.

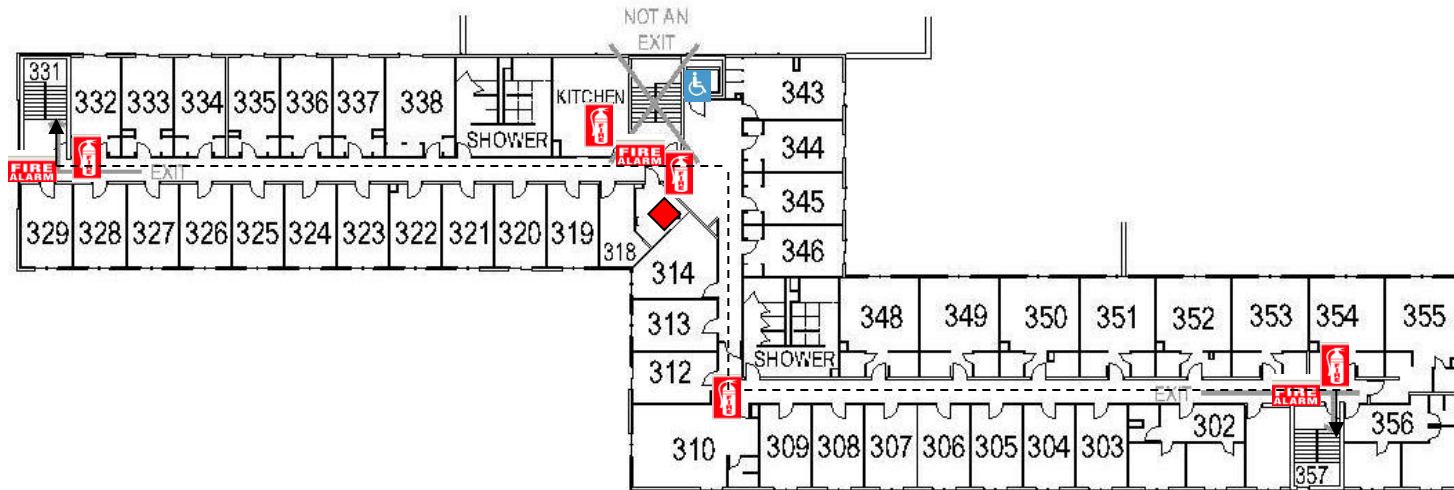

IF THERE IS AN EVACUATION EMERGENCY:

- Assist persons with disabilities
- Exit the building using the nearest exit **DO NOT USE ELEVATORS!**
- Report to the nearest designated area.
- Call 911 (9-911 if on a campus phone)
- Call Public Safety at 605-394-6100
- Do not re-enter until authorized to do so.

CAMPUS ESCORT SERVICE:

Public Safety Provides Escort Services: To arrange an escort, call 605-394-6100, and a Public Safety Employee will escort you from any campus building to another.

HOWARD PETERSON HALL – 3RD FLOOR

Campus Emergency Numbers

Emergency 911 (9-911 from a campus phone)

SDSMT Public Safety (605)394-6100

Emergency Information Recording (605)394-2210















SOUTH DAKOTA MINES

An engineering, science and technology university

Building Managers

Samantha Wright
Darrin Pagnac

KEY

-  You Are Here
-  Evacuation Route
-  Exit
-  Emergency Assembly Point
-  Restroom
-  Automated External Defibrillator
-  Fire Extinguisher
-  Fire Alarm (Pull Station)
-  Fire Alarm Control Panel
-  Fire Sprinkler Shut-off
-  Stand Pipe or FDC
-  Symbol of Accessibility
-  Tornado/Severe Thunderstorm Refuge Areas
-  First Aid Kit
-  Eye Wash/Safety Shower
-  Spill Kit

IF THERE IS AN EVACUATION EMERGENCY:

- Assist persons with disabilities
- Exit the building using the nearest exit **DO NOT USE ELEVATORS!**
- Report to the nearest designated area.
- Call 911 (9-911 if on a campus phone)
- Call Public Safety at 605-394-6100
- Do not re-enter until authorized to do so.

CAMPUS ESCORT SERVICE:

Public Safety Provides Escort Services: To arrange an escort, call 605-394-6100, and a Public Safety Employee will escort you from any campus building to another.



James E. Martin Paleontology Research Center – 1ST Floor

Campus Emergency Numbers

Emergency 911 (9-911 from a campus phone)

SDSMT Public Safety (605)394-6100

Emergency Information Recording (605)394-2210



SOUTH DAKOTA MINES

An engineering, science and technology university

Building Managers

Samantha Wright
Darrin Pagnac

KEY

- You Are Here
- Evacuation Route
- Exit
- Emergency Assembly Point
- Restroom
- Automated External Defibrillator
- Fire Extinguisher
- Fire Alarm (Pull Station)
- Fire Alarm Control Panel
- Fire Sprinkler Shut-off
- Stand Pipe or FDC
- Symbol of Accessibility
- Tornado/Severe Thunderstorm
Refuge Areas
- First Aid Kit
- Eye Wash/Safety Shower
- Spill Kit



In the event of a tornado, please proceed to areas marked on the first floor map.



IF THERE IS AN EVACUATION EMERGENCY:

- Assist persons with disabilities
- Exit the building using the nearest exit **DO NOT USE ELEVATORS!**
- Report to the nearest designated area.
- Call 911 (9-911 if on a campus phone)
- Call Public Safety at 605-394-6100
- Do not re-enter until authorized to do so.

CAMPUS ESCORT SERVICE:

Public Safety Provides Escort Services: To arrange an escort, call 605-394-6100, and a Public Safety Employee will escort you from any campus building to another.

James E. Martin Paleontology Research Center– 2ND FLOOR

Campus Emergency Numbers

Emergency 911 (9-911 from a campus phone)

SDSMT Public Safety (605)394-6100

Emergency Information Recording (605)394-2210



SOUTH DAKOTA MINES

















An engineering, science and technology university

Building Managers

Anita Brenneman

Seth Nichols

KEY

-  You Are Here
-  Evacuation Route
-  Exit
-  Emergency Assembly Point
-  Restroom
-  Automated External Defibrillator
-  Fire Extinguisher
-  Fire Alarm (Pull Station)
-  Fire Alarm Control Panel
-  Fire Sprinkler Shut-off
-  Stand Pipe or FDC
-  Symbol of Accessibility
-  Tornado/Severe Thunderstorm Refuge Areas
-  First Aid Kit
-  Eye Wash/Safety Shower
-  Spill Kit

IF THERE IS AN EVACUATION EMERGENCY:

- Assist persons with disabilities
- Exit the building using the nearest exit **DO NOT USE ELEVATORS!**
- Report to the nearest designated area.
- Call 911 (9-911 if on a campus phone)
- Call Public Safety at 605-394-6100
- Do not re-enter until authorized to do so.

CAMPUS ESCORT SERVICE:

Public Safety Provides Escort Services: To arrange an escort, call 605-394-6100, and a Public Safety Employee will escort you from any campus building to another.

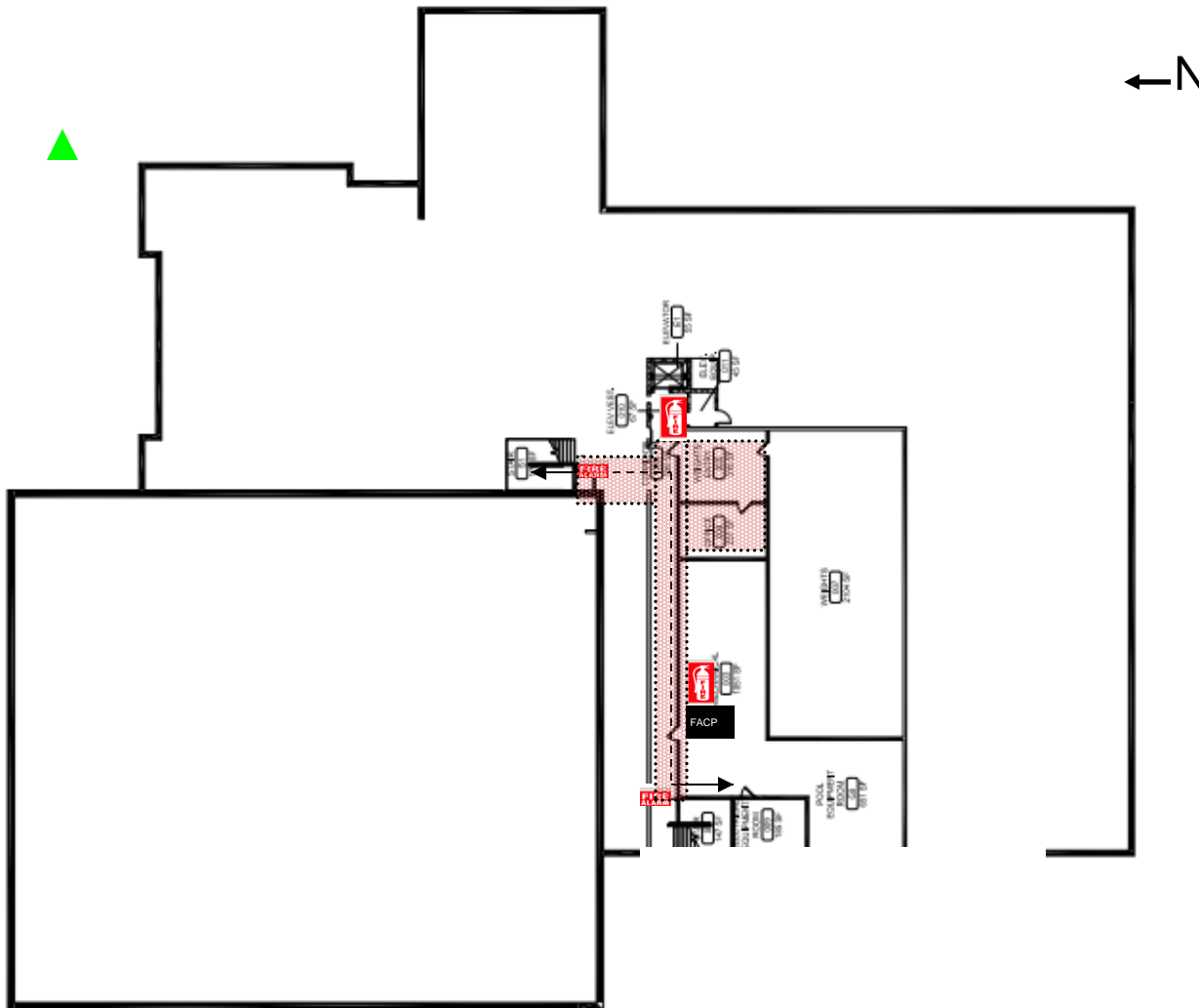

King Center – BASEMENT

Campus Emergency Numbers

Emergency 911 (9-911 from a campus phone)

SDSMT Public Safety (605)394-6100

Emergency Information Recording (605)394-2210



SOUTH DAKOTA MINES

An engineering, science and technology university

Building Managers

Anita Brenneman
Seth Nichols

KEY

	You Are Here
	Evacuation Route
	Exit
	Emergency Assembly Point
	Restroom
	Automated External Defibrillator
	Fire Extinguisher
	Fire Alarm (Pull Station)
	Fire Alarm Control Panel
	Fire Sprinkler Shut-off
	Stand Pipe or FDC
	Symbol of Accessibility
	Tornado/Severe Thunderstorm Refuge Areas
	First Aid Kit
	Eye Wash/Safety Shower
	Spill Kit

In the event of a tornado, please proceed to areas marked on the first floor map.

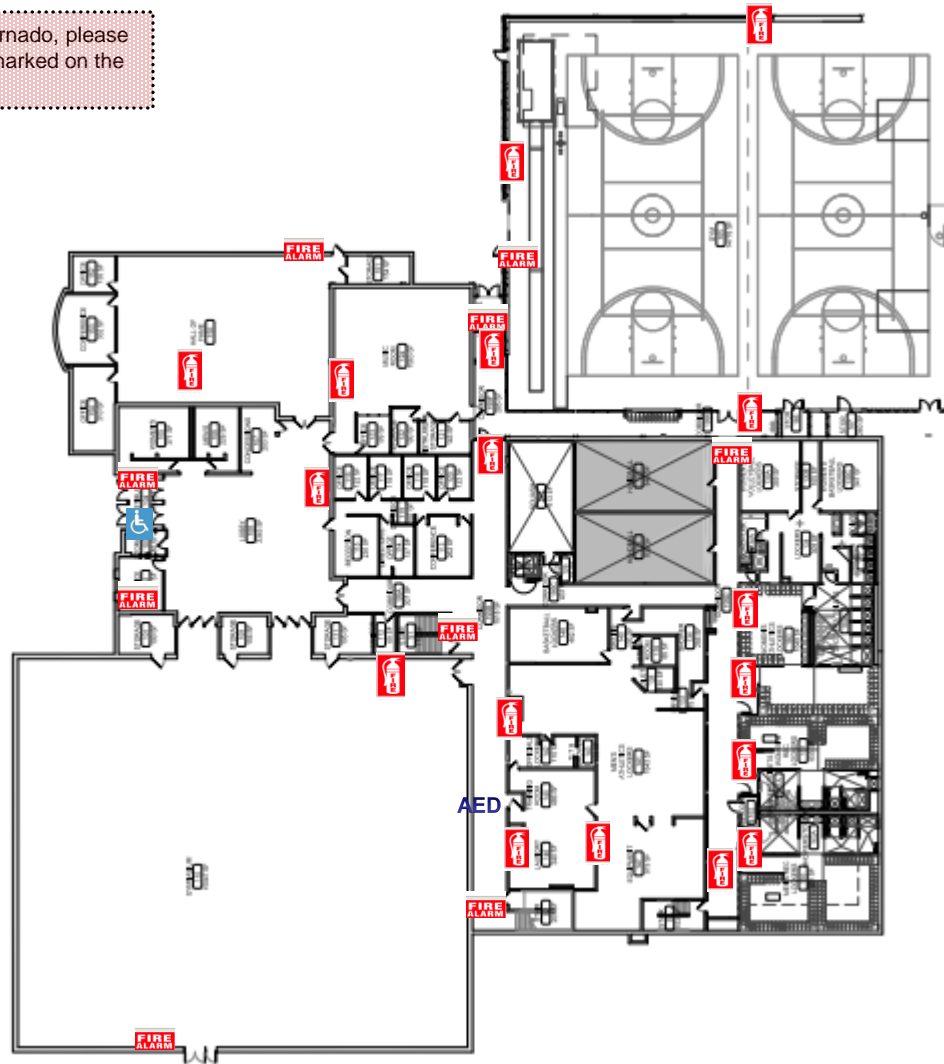

King Center – 1ST FLOOR

IF THERE IS AN EVACUATION EMERGENCY:

- Assist persons with disabilities
- Exit the building using the nearest exit **DO NOT USE ELEVATORS!**
- Report to the nearest designated area.
- Call 911 (9-911 if on a campus phone)
- Call Public Safety at 605-394-6100
- Do not re-enter until authorized to do so.

CAMPUS ESCORT SERVICE:

Public Safety Provides Escort Services: To arrange an escort, call 605-394-6100, and a Public Safety Employee will escort you from any campus building to another.

Campus Emergency Numbers

Emergency 911 (9-911 from a campus phone)

SDSMT Public Safety (605)394-6100

Emergency Information Recording (605)394-2210



















SOUTH DAKOTA MINES

An engineering, science and technology university

Building Managers

Anita Brenneman
Seth Nichols

KEY

-  You Are Here
-  Evacuation Route
-  Exit
-  Emergency Assembly Point
-  Restroom
-  Automated External Defibrillator
-  Fire Extinguisher
-  Fire Alarm (Pull Station)
-  Fire Alarm Control Panel
-  Fire Sprinkler Shut-off
-  Stand Pipe or FDC
-  Symbol of Accessibility
-  Tornado/Severe Thunderstorm
Refuge Areas
-  First Aid Kit
-  Eye Wash/Safety Shower
-  Spill Kit

In the event of a tornado, please proceed to areas marked on the first floor map.

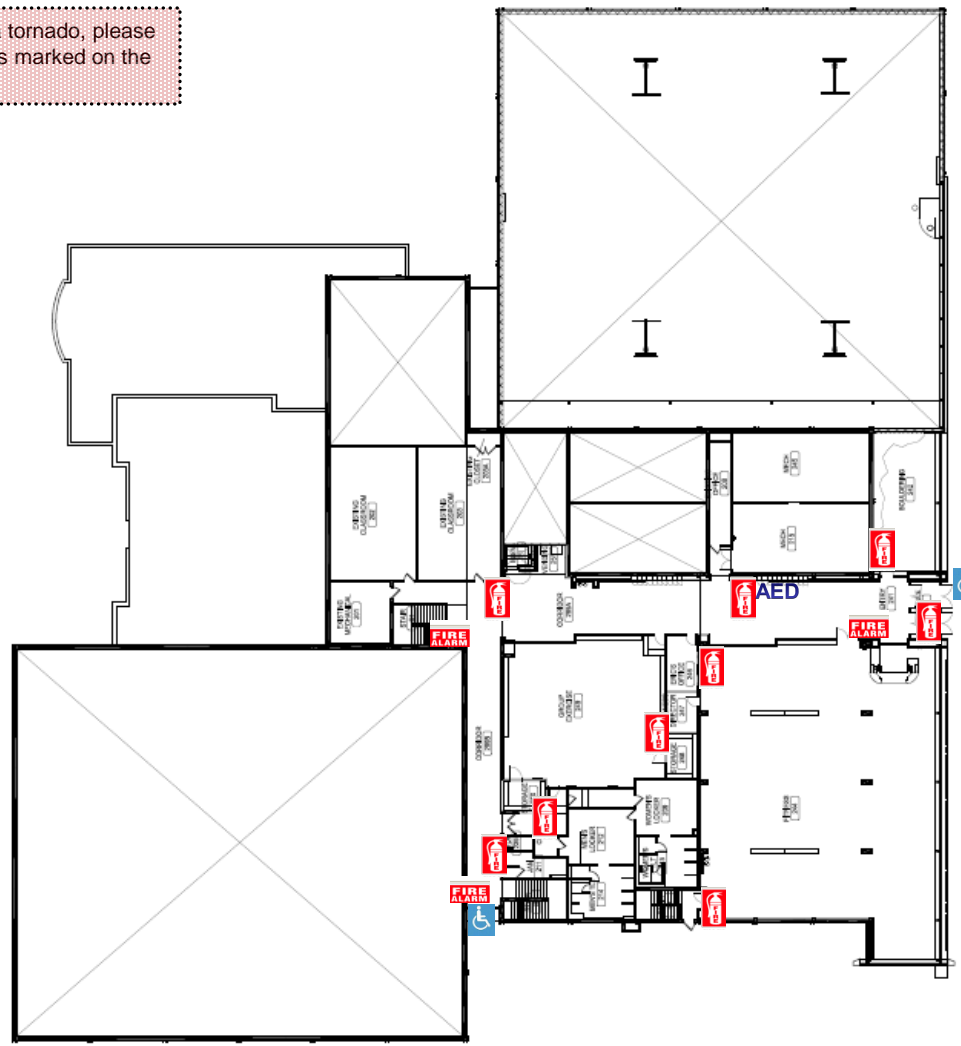
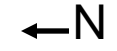

King Center – 2ND FLOOR

IF THERE IS AN EVACUATION EMERGENCY:

- Assist persons with disabilities
- Exit the building using the nearest exit **DO NOT USE ELEVATORS!**
- Report to the nearest designated area.
- Call 911 (9-911 if on a campus phone)
- Call Public Safety at 605-394-6100
- Do not re-enter until authorized to do so.

CAMPUS ESCORT SERVICE:

Public Safety Provides Escort Services: To arrange an escort, call 605-394-6100, and a Public Safety Employee will escort you from any campus building to another.

Campus Emergency Numbers

Emergency 911 (9-911 from a campus phone)

SDSMT Public Safety (605)394-6100

Emergency Information Recording (605)394-2210

**SOUTH DAKOTA MINES**

An engineering, science and technology university

Building ManagersJanet Taylor
Lisa Carlson
Christal Krein**KEY**

- You Are Here
- Evacuation Route
- Exit
- Emergency Assembly Point
- Restroom
- Automated External Defibrillator
- Fire Extinguisher
- Fire Alarm (Pull Station)
- Fire Alarm Control Panel
- Fire Sprinkler Shut-off
- Stand Pipe or FDC
- Symbol of Accessibility
- Tornado/Severe Thunderstorm Refuge Areas
- First Aid Kit
- Eye Wash/Safety Shower
- Spill Kit

IF THERE IS AN EVACUATION EMERGENCY:

- Assist persons with disabilities
- Exit the building using the nearest exit **DO NOT USE ELEVATORS!**
- Report to the nearest designated area.
- Call 911 (9-911 if on a campus phone)
- Call Public Safety at 605-394-6100
- Do not re-enter until authorized to do so.

CAMPUS ESCORT SERVICE:

Public Safety Provides Escort Services: To arrange an escort, call 605-394-6100, and a Public Safety Employee will escort you from any campus building to another.

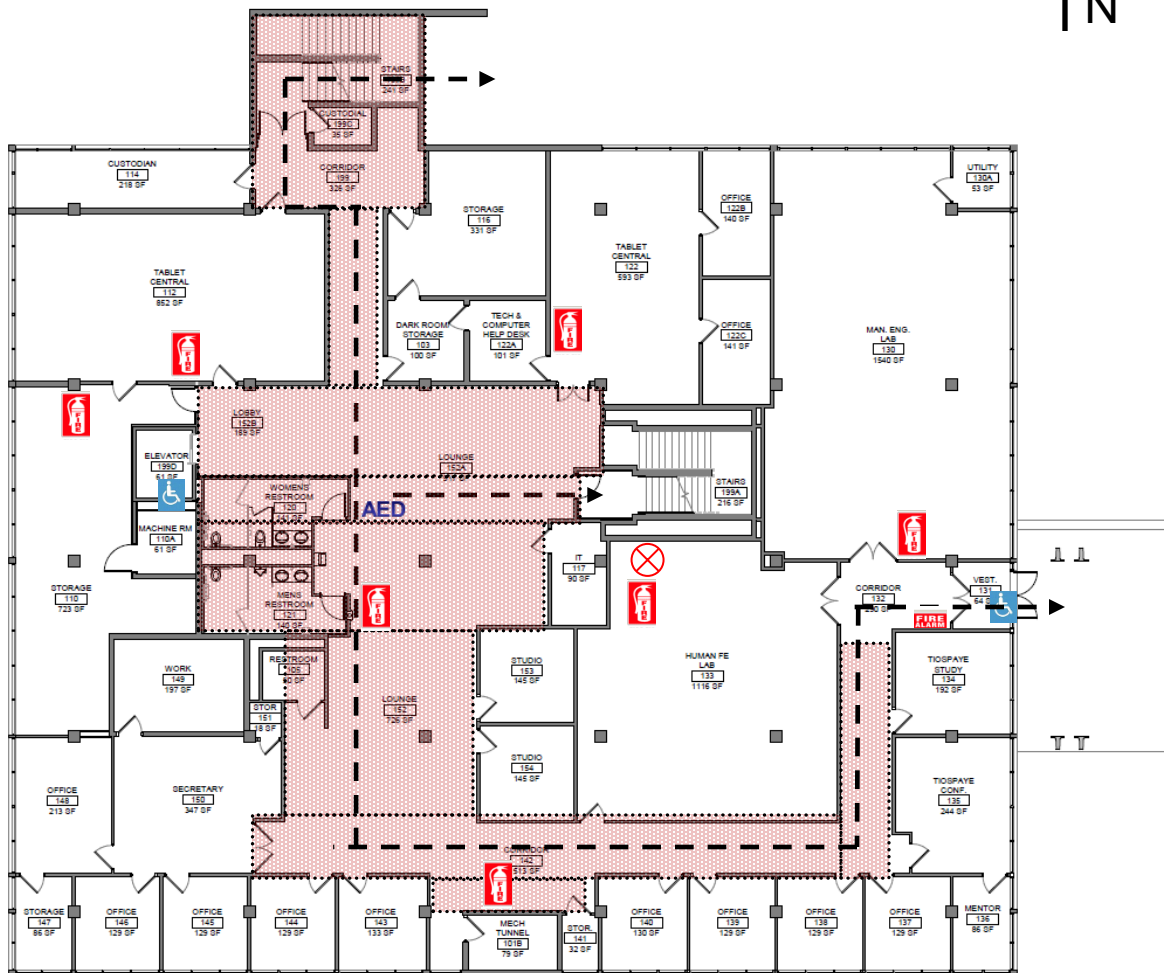

Quad Area

Library - Lower Level

Campus Emergency Numbers

Emergency 911 (9-911 from a campus phone)

SDSMT Public Safety (605)394-6100

Emergency Information Recording (605)394-2210



SOUTH DAKOTA MINES

An engineering, science and technology university

Building Managers

Janet Taylor
Lisa Carlson
Christal Krein

KEY

- You Are Here
- Evacuation Route
- Exit
- Emergency Assembly Point
- Restroom
- Automated External Defibrillator
- Fire Extinguisher
- Fire Alarm (Pull Station)
- Fire Alarm Control Panel
- Fire Sprinkler Shut-off
- Stand Pipe or FDC
- Symbol of Accessibility
- Tornado/Severe Thunderstorm Refuge Areas
- First Aid Kit
- Eye Wash/Safety Shower
- Spill Kit

In the event of a tornado, please proceed to areas marked on the first floor map.

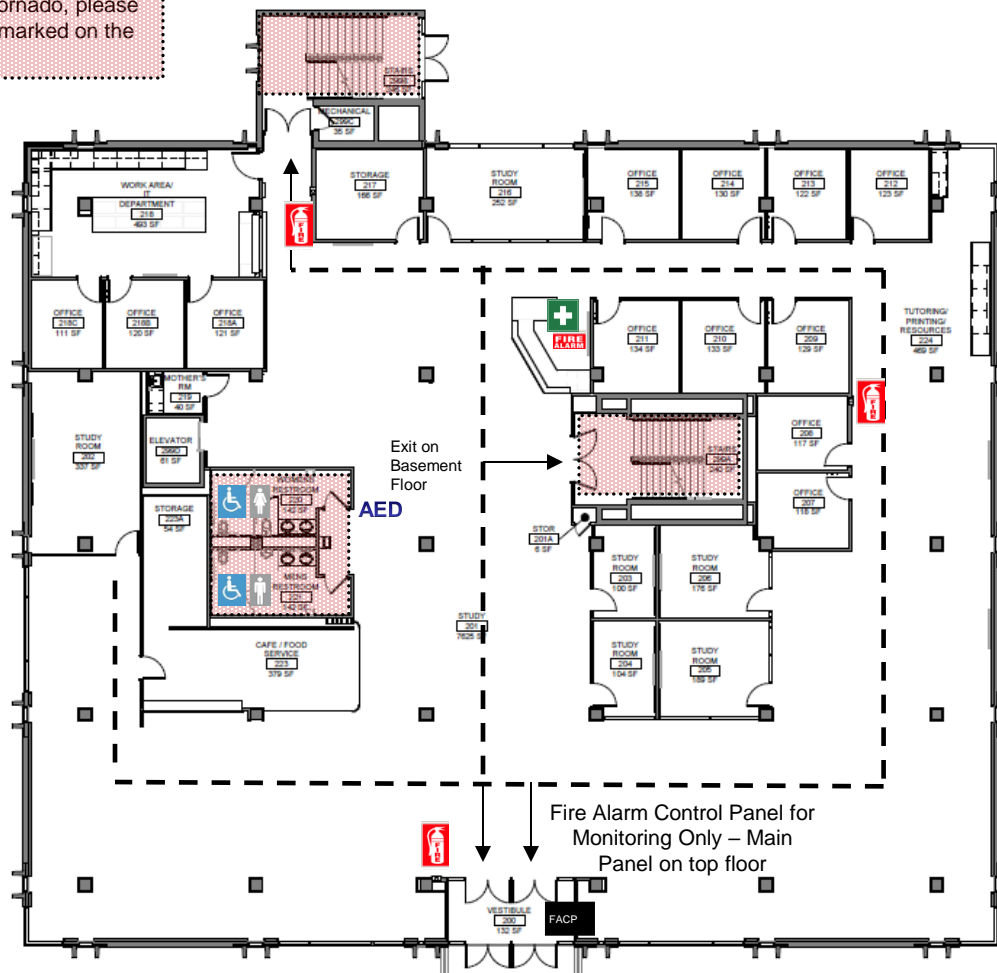

IF THERE IS AN EVACUATION EMERGENCY:

- Assist persons with disabilities
- Exit the building using the nearest exit **DO NOT USE ELEVATORS!**
- Report to the nearest designated area.
- Call 911 (9-911 if on a campus phone)
- Call Public Safety at 605-394-6100
- Do not re-enter until authorized to do so.

CAMPUS ESCORT SERVICE:

Public Safety Provides Escort Services: To arrange an escort, call 605-394-6100, and a Public Safety Employee will escort you from any campus building to another.

Library- Main Level

Campus Emergency Numbers

Emergency 911 (9-911 from a campus phone)

SDSMT Public Safety (605)394-6100

Emergency Information Recording (605)394-2210



SOUTH DAKOTA MINES

An engineering, science and technology university

Building Managers

Janet Taylor
Lisa Carlson
Christal Krein

KEY

- You Are Here
- Evacuation Route
- Exit
- Emergency Assembly Point
- Restroom
- Automated External Defibrillator
- Fire Extinguisher
- Fire Alarm (Pull Station)
- Fire Alarm Control Panel
- Fire Sprinkler Shut-off
- Stand Pipe or FDC
- Symbol of Accessibility
- Tornado/Severe Thunderstorm Refuge Areas
- First Aid Kit
- Eye Wash/Safety Shower
- Spill Kit

In the event of a tornado, please proceed to areas marked on the first floor map.

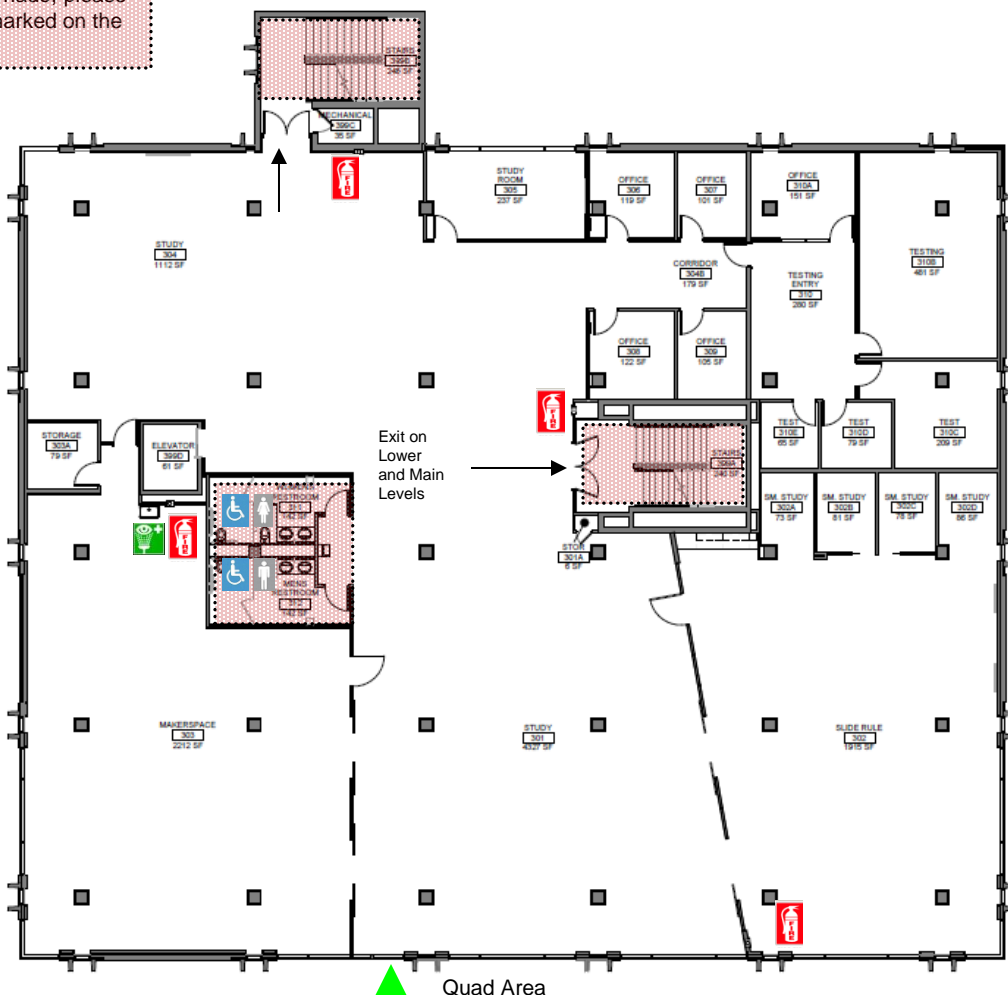

IF THERE IS AN EVACUATION EMERGENCY:

- Assist persons with disabilities
- Exit the building using the nearest exit **DO NOT USE ELEVATORS!**
- Report to the nearest designated area.
- Call 911 (9-911 if on a campus phone)
- Call Public Safety at 605-394-6100
- Do not re-enter until authorized to do so.

CAMPUS ESCORT SERVICE:

Public Safety Provides Escort Services: To arrange an escort, call 605-394-6100, and a Public Safety Employee will escort you from any campus building to another.

Library- 3rd FLOOR

Campus Emergency Numbers

Emergency 911 (9-911 from a campus phone)

SDSMT Public Safety (605)394-6100

Emergency Information Recording (605)394-2210



SOUTH DAKOTA MINES

An engineering, science and technology university

Building Managers

Janet Taylor
Lisa Carlson
Christal Krein

KEY

- You Are Here
- Evacuation Route
- Exit
- Emergency Assembly Point
- Restroom
- Automated External Defibrillator
- Fire Extinguisher
- Fire Alarm (Pull Station)
- Fire Alarm Control Panel
- Fire Sprinkler Shut-off
- Stand Pipe or FDC
- Symbol of Accessibility
- Tornado/Severe Thunderstorm Refuge Areas
- First Aid Kit
- Eye Wash/Safety Shower
- Spill Kit

In the event of a tornado, please proceed to areas marked on the first floor map.

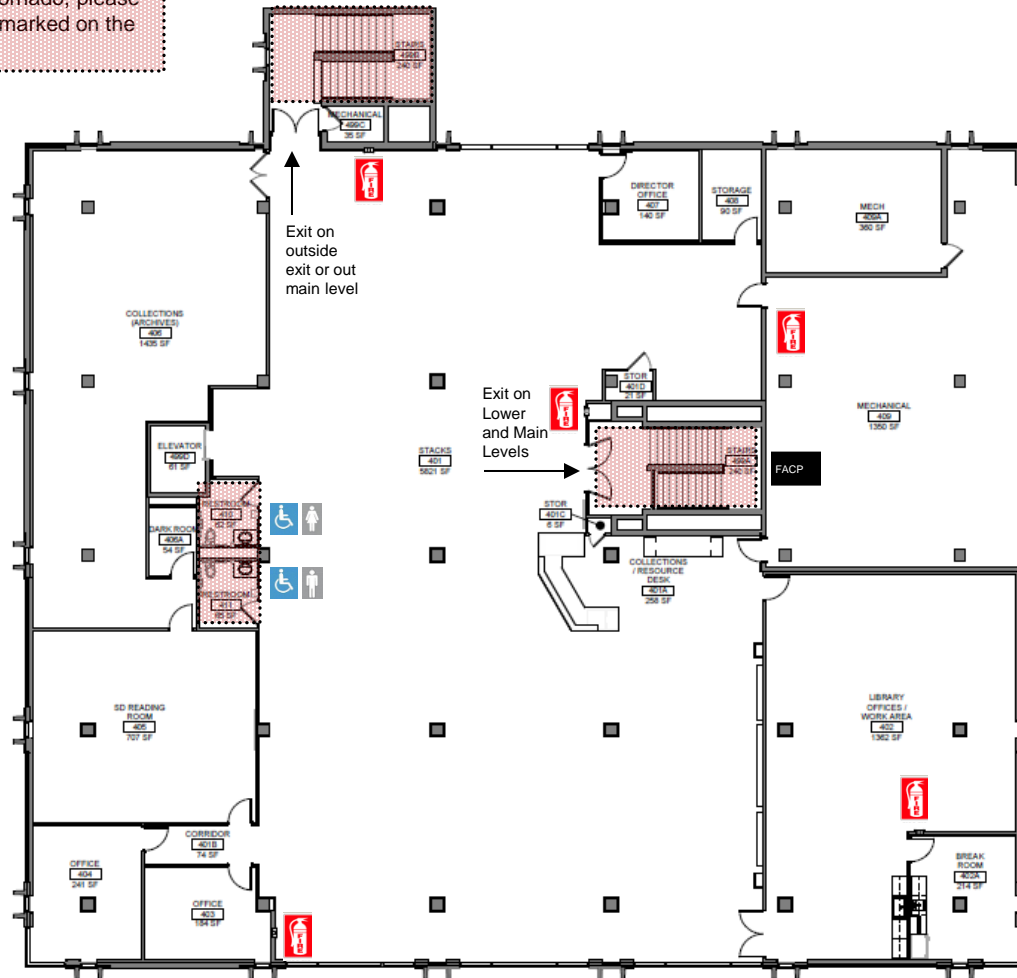

Quad Area

Library- 4th FLOOR

IF THERE IS AN EVACUATION EMERGENCY:

- Assist persons with disabilities
- Exit the building using the nearest exit **DO NOT USE ELEVATORS!**
- Report to the nearest designated area.
- Call 911 (9-911 if on a campus phone)
- Call Public Safety at 605-394-6100
- Do not re-enter until authorized to do so.

CAMPUS ESCORT SERVICE:

Public Safety Provides Escort Services: To arrange an escort, call 605-394-6100, and a Public Safety Employee will escort you from any campus building to another.

Campus Emergency Numbers

Emergency 911 (9-911 from a campus phone)

SDSMT Public Safety (605)394-6100

Emergency Information Recording (605)394-2210



SOUTH DAKOTA MINES

An engineering, science and technology university

Building Managers

Dr. Travis Kowalski
Cathy Durkin

KEY

- You Are Here
- Evacuation Route
- Exit
- Emergency Assembly Point
- Restroom
- Automated External Defibrillator
- Fire Extinguisher
- Fire Alarm (Pull Station)
- Fire Alarm Control Panel
- Fire Sprinkler Shut-off
- Stand Pipe or FDC
- Symbol of Accessibility
- Tornado/Severe Thunderstorm Refuge Areas
- First Aid Kit
- Eye Wash/Safety Shower
- Spill Kit

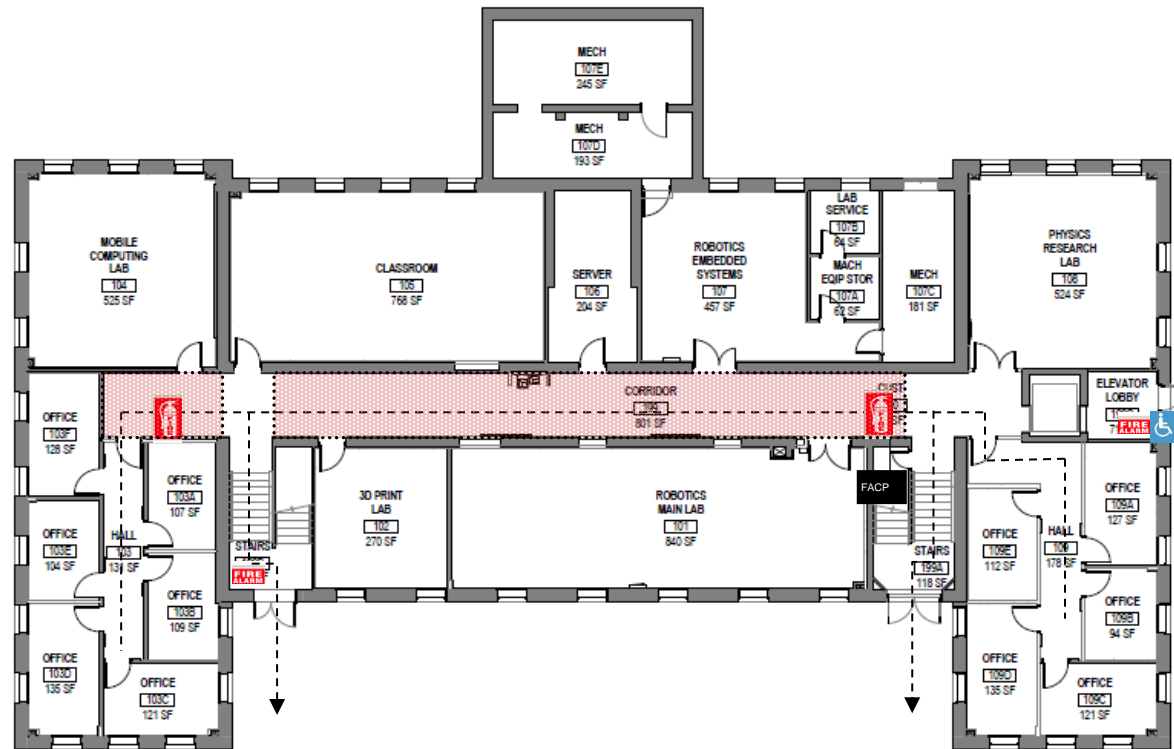

IF THERE IS AN EVACUATION EMERGENCY:

- Assist persons with disabilities
- Exit the building using the nearest exit **DO NOT USE ELEVATORS!**
- Report to the nearest designated area.
- Call 911 (9-911 if on a campus phone)
- Call Public Safety at 605-394-6100
- Do not re-enter until authorized to do so.

CAMPUS ESCORT SERVICE:

Public Safety Provides Escort Services: To arrange an escort, call 605-394-6100, and a Public Safety Employee will escort you from any campus building to another.

McLaury – 1ST FLOOR

Quad Area

Campus Emergency Numbers

Emergency 911 (9-911 from a campus phone)

SDSMT Public Safety (605)394-6100

Emergency Information Recording (605)394-2210



SOUTH DAKOTA MINES

An engineering, science and technology university

Building Managers

Dr. Travis Kowalski
Cathy Durkin

KEY

- You Are Here
- Evacuation Route
- Exit
- Emergency Assembly Point
- Restroom
- Automated External Defibrillator
- Fire Extinguisher
- Fire Alarm (Pull Station)
- Fire Alarm Control Panel
- Fire Sprinkler Shut-off
- Stand Pipe or FDC
- Symbol of Accessibility
- Tornado/Severe Thunderstorm Refuge Areas
- First Aid Kit
- Eye Wash/Safety Shower
- Spill Kit

In the event of a tornado, please proceed to areas marked on the first floor map.

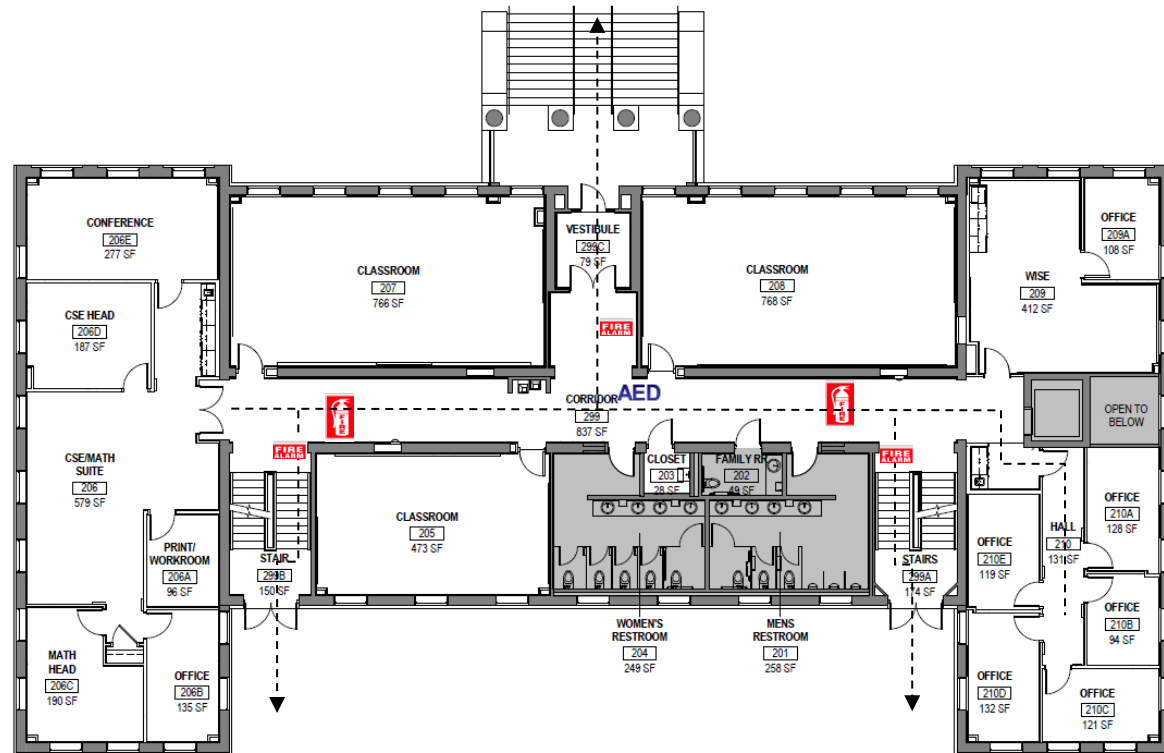

IF THERE IS AN EVACUATION EMERGENCY:

- Assist persons with disabilities
- Exit the building using the nearest exit **DO NOT USE ELEVATORS!**
- Report to the nearest designated area.
- Call 911 (9-911 if on a campus phone)
- Call Public Safety at 605-394-6100
- Do not re-enter until authorized to do so.

CAMPUS ESCORT SERVICE:

Public Safety Provides Escort Services: To arrange an escort, call 605-394-6100, and a Public Safety Employee will escort you from any campus building to another.

McLaury – 2ND FLOOR

Quad Area

Campus Emergency Numbers

Emergency 911 (9-911 from a campus phone)

SDSMT Public Safety (605)394-6100

Emergency Information Recording (605)394-2210



SOUTH DAKOTA MINES

An engineering, science and technology university

Building Managers

Dr. Travis Kowalski
Cathy Durkin

KEY

- You Are Here
- Evacuation Route
- Exit
- Emergency Assembly Point
- Restroom
- Automated External Defibrillator
- Fire Extinguisher
- Fire Alarm (Pull Station)
- Fire Alarm Control Panel
- Fire Sprinkler Shut-off
- Stand Pipe or FDC
- Symbol of Accessibility
- Tornado/Severe Thunderstorm
Refuge Areas
- First Aid Kit
- Eye Wash/Safety Shower
- Spill Kit

In the event of a tornado, please proceed to areas marked on the first floor map.

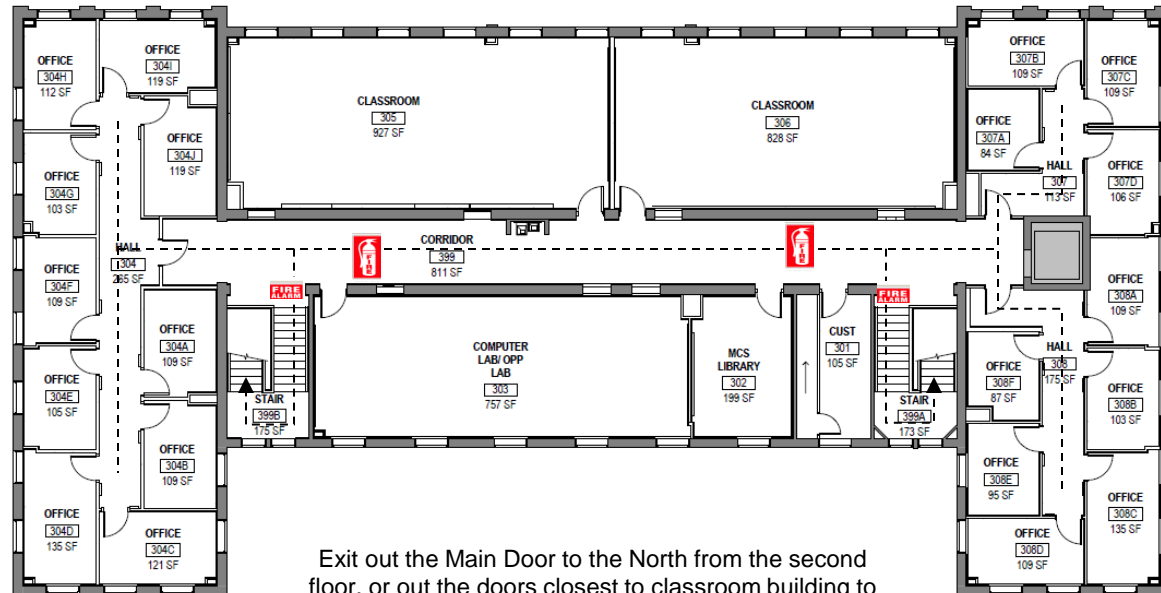

Exit out the Main Door to the North from the second floor, or out the doors closest to classroom building to the south.

Quad Area

IF THERE IS AN EVACUATION EMERGENCY:

- Assist persons with disabilities
- Exit the building using the nearest exit **DO NOT USE ELEVATORS!**
- Report to the nearest designated area.
- Call 911 (9-911 if on a campus phone)
- Call Public Safety at 605-394-6100
- Do not re-enter until authorized to do so.

CAMPUS ESCORT SERVICE:

Public Safety Provides Escort Services: To arrange an escort, call 605-394-6100, and a Public Safety Employee will escort you from any campus building to another.

McLaury – 3RD FLOOR

Campus Emergency Numbers

Emergency 911 (9-911 from a campus phone)

SDSMT Public Safety (605)394-6100

Emergency Information Recording (605)394-2210



SOUTH DAKOTA MINES

An engineering, science and technology university

















Building Managers

Parker Pombrio

Jessica Zacher

Jennifer Parrow

KEY

-  You Are Here
-  Evacuation Route
-  Exit
-  Emergency Assembly Point
-  Restroom
-  Automated External Defibrill
-  Fire Extinguisher
-  Fire Alarm (Pull Station)
-  Fire Alarm Control Panel
-  Fire Sprinkler Shut-off
-  Stand Pipe or FDC
-  Symbol of Accessibility
-  Tornado/Severe Thundersto
Refuge Areas
-  First Aid Kit
-  Eye Wash/Safety Shower
-  Spill Kit

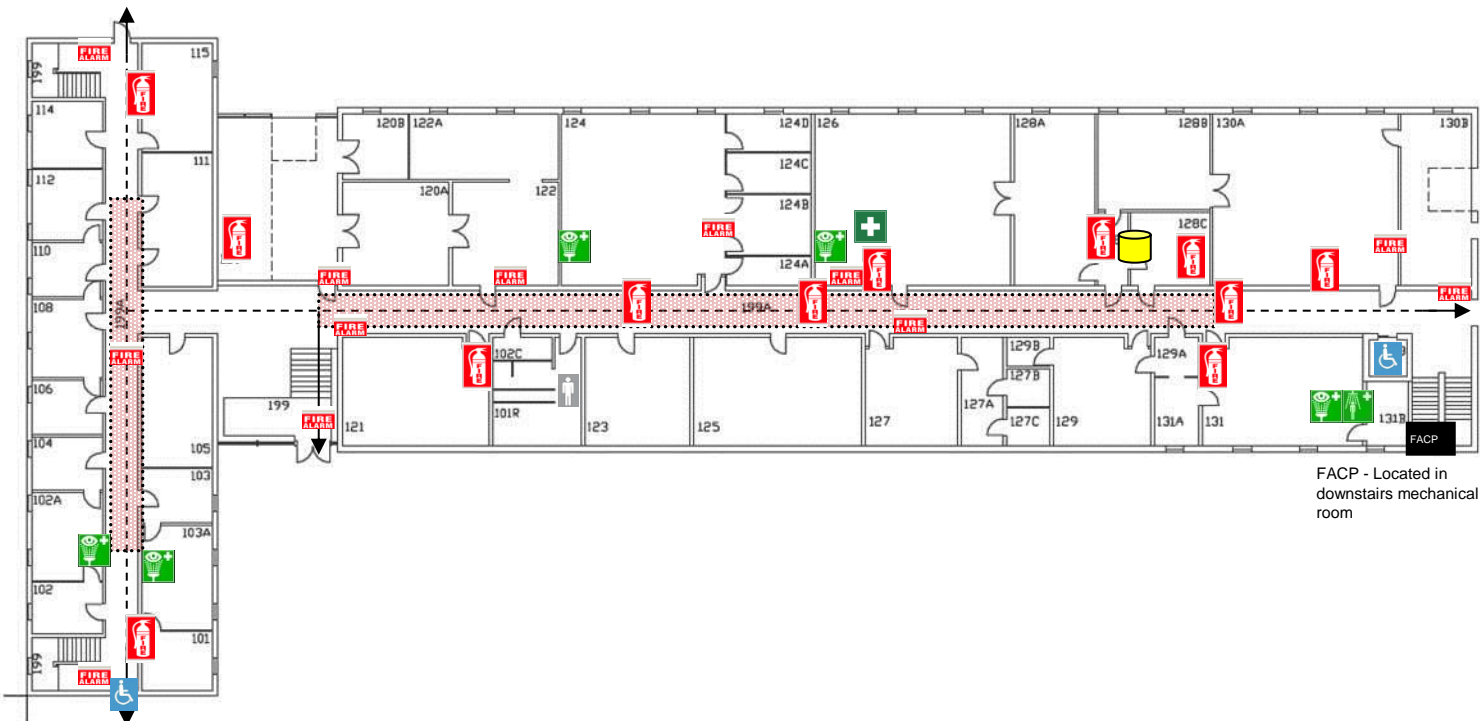

FACP - Located in downstairs mechanical room

 Quad Area

IF THERE IS AN EVACUATION EMERGENCY:

- Assist persons with disabilities
- Exit the building using the nearest exit **DO NOT USE ELEVATORS!**
- Report to the nearest designated area.
- Call 911 (9-911 if on a campus phone)
- Call Public Safety at 605-394-6100
- Do not re-enter until authorized to do so.

CAMPUS ESCORT SERVICE:

Public Safety Provides Escort Services: To arrange an escort, call 605-394-6100, and a Public Safety Employee will escort you from any campus building to another.

MINERAL INDUSTRY BUILDING – 1ST FLOOR

Campus Emergency Numbers

Emergency 911 (9-911 from a campus phone)

SDSMT Public Safety (605)394-6100

Emergency Information Recording (605)394-2210



SOUTH DAKOTA MINES

An engineering, science and technology university

Building Managers

Parker Pombrio

Jessica Zacher

Jennifer Parrow

KEY

- You Are Here
- Evacuation Route
- Exit
- Emergency Assembly Point
- Restroom
- Automated External Defibrillator
- Fire Extinguisher
- Fire Alarm (Pull Station)
- Fire Alarm Control Panel
- Fire Sprinkler Shut-off
- Stand Pipe or FDC
- Symbol of Accessibility
- Tornado/Severe Thunderstorm
Refuge Areas
- First Aid Kit
- Eye Wash/Safety Shower
- Spill Kit

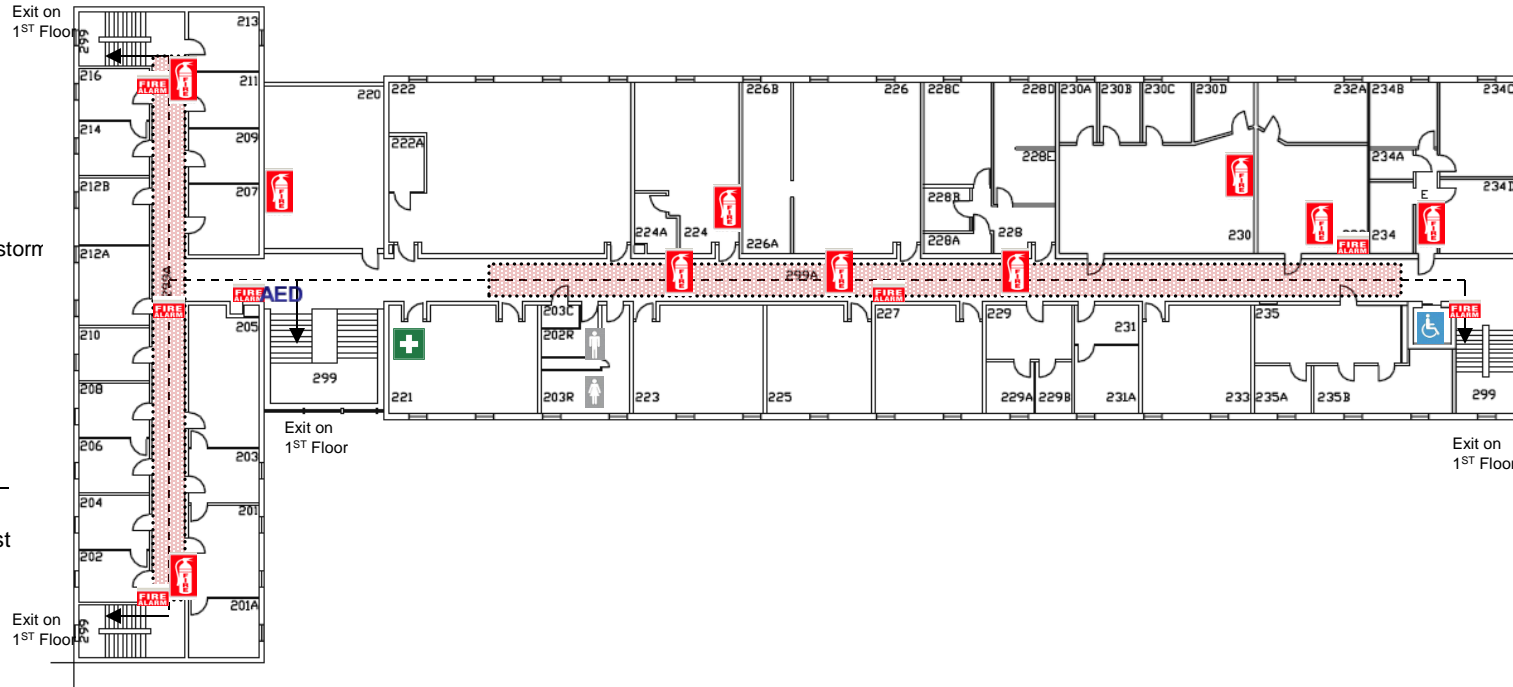

IF THERE IS AN EVACUATION EMERGENCY:

- Assist persons with disabilities
- Exit the building using the nearest exit **DO NOT USE ELEVATORS!**
- Report to the nearest designated area.
- Call 911 (9-911 if on a campus phone)
- Call Public Safety at 605-394-6100
- Do not re-enter until authorized to do so.

CAMPUS ESCORT SERVICE:

Public Safety Provides Escort Services: To arrange an escort, call 605-394-6100, and a Public Safety Employee will escort you from any campus building to another.

Quad Area

MINERAL INDUSTRY BUILDING – 2ND FLOOR

Campus Emergency Numbers

Emergency 911 (9-911 from a campus phone)

SDSMT Public Safety (605)394-6100

Emergency Information Recording (605)394-2210



SOUTH DAKOTA MINES

An engineering, science and technology university

Building Managers

Parker Pombrio
Jessica Zacher
Jennifer Parrow

KEY

- You Are Here
- Evacuation Route
- Exit
- Emergency Assembly Point
- Restroom
- Automated External Defibrillator
- Fire Extinguisher
- Fire Alarm (Pull Station)
- Fire Alarm Control Panel
- Fire Sprinkler Shut-off
- Stand Pipe or FDC
- Symbol of Accessibility
- Tornado/Severe Thunderstorm
Refuge Areas
- First Aid Kit
- Eye Wash/Safety Shower
- Spill Kit

In the event of a tornado, please proceed to areas marked on the first and second floor maps.

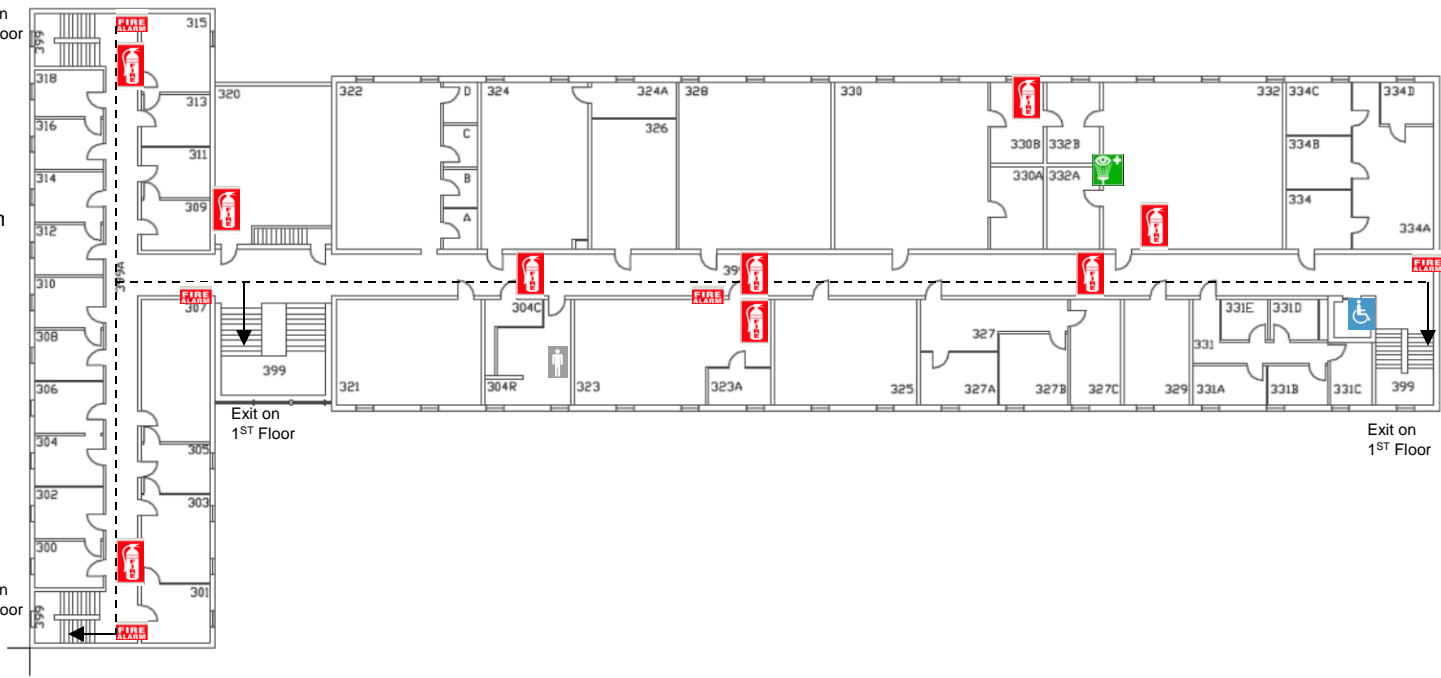

IF THERE IS AN EVACUATION EMERGENCY:

- Assist persons with disabilities
- Exit the building using the nearest exit **DO NOT USE ELEVATORS!**
- Report to the nearest designated area.
- Call 911 (9-911 if on a campus phone)
- Call Public Safety at 605-394-6100
- Do not re-enter until authorized to do so.

CAMPUS ESCORT SERVICE:

Public Safety Provides Escort Services: To arrange an escort, call 605-394-6100, and a Public Safety Employee will escort you from any campus building to another.

Quad Area

MINERAL INDUSTRY BUILDING – 3RD FLOOR

Campus Emergency Numbers

Emergency 911 (9-911 from a campus phone)

SDSMT Public Safety (605)394-6100

Emergency Information Recording (605)394-2210



SOUTH DAKOTA MINES

An engineering, science and technology university

















Building Managers

Angela Mettler

Gina Fiorello

Aaron Grimm, Darrah Steffen

KEY

-  You Are Here
-  Evacuation Route
-  Exit
-  Emergency Assembly Point
-  Restroom
-  Automated External Defibrillator
-  Fire Extinguisher
-  Fire Alarm (Pull Station)
-  Fire Alarm Control Panel
-  Fire Sprinkler Shut-off
-  Stand Pipe or FDC
-  Symbol of Accessibility
-  Tornado/Severe Thunderstorm Refuge Areas
-  First Aid Kit
-  Eye Wash/Safety Shower
-  Spill Kit

IF THERE IS AN EVACUATION EMERGENCY:

- Assist persons with disabilities
- Exit the building using the nearest exit **DO NOT USE ELEVATORS!**
- Report to the nearest designated area.
- Call 911 (9-911 if on a campus phone)
- Call Public Safety at 605-394-6100
- Do not re-enter until authorized to do so.

CAMPUS ESCORT SERVICE:

Public Safety Provides Escort Services: To arrange an escort, call 605-394-6100, and a Public Safety Employee will escort you from any campus building to another.

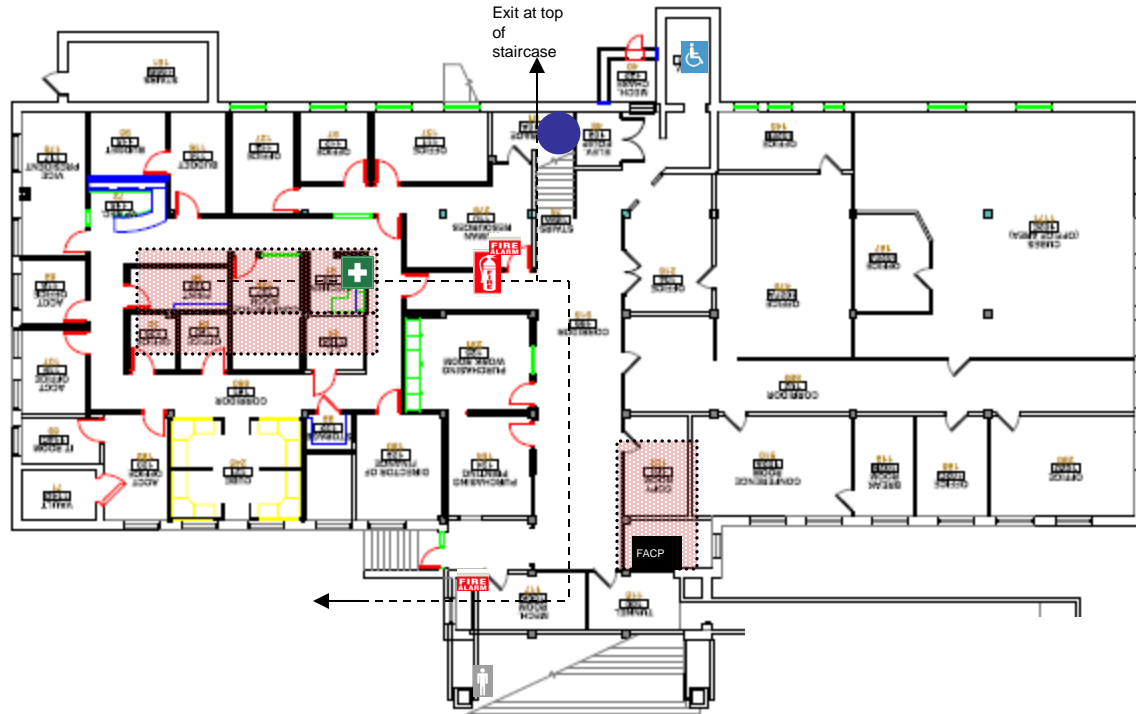

 Flag Pole Across Street

O'HARRA BUILDING – 1ST FLOOR

Campus Emergency Numbers

Emergency 911 (9-911 from a campus phone)

SDSMT Public Safety (605)394-6100

Emergency Information Recording (605)394-2210



SOUTH DAKOTA MINES

An engineering, science and technology university

Building Managers

Angela Mettler
Gina Fiorello
Aaron Grimm, Darrah Steffen

KEY

- You Are Here
- Evacuation Route
- Exit
- Emergency Assembly Point
- Restroom
- Automated External Defibrillator
- Fire Extinguisher
- Fire Alarm (Pull Station)
- Fire Alarm Control Panel
- Fire Sprinkler Shut-off
- Stand Pipe or FDC
- Symbol of Accessibility
- Tornado/Severe Thunderstorm
Refuge Areas
- First Aid Kit
- Eye Wash/Safety Shower
- Spill Kit

In the event of a tornado, please proceed to areas marked on the first floor map.

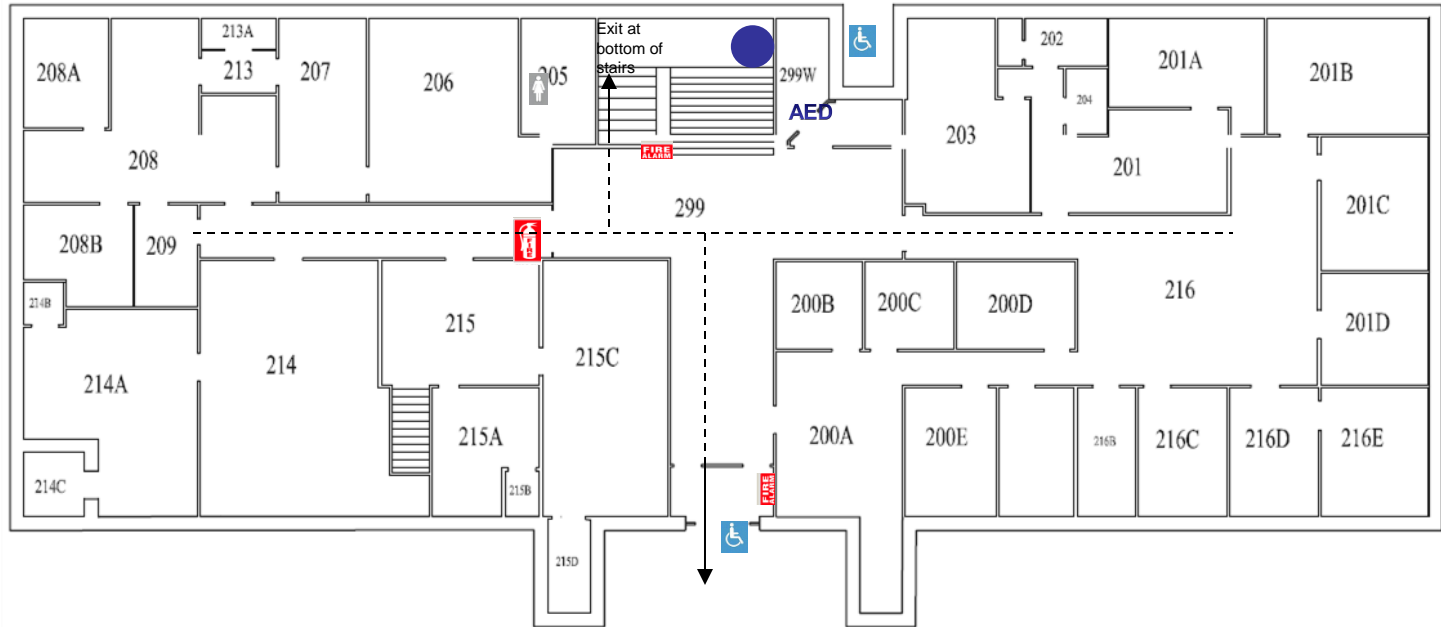

IF THERE IS AN EVACUATION EMERGENCY:

- Assist persons with disabilities
- Exit the building using the nearest exit **DO NOT USE ELEVATORS!**
- Report to the nearest designated area.
- Call 911 (9-911 if on a campus phone)
- Call Public Safety at 605-394-6100
- Do not re-enter until authorized to do so.

CAMPUS ESCORT SERVICE:

Public Safety Provides Escort Services: To arrange an escort, call 605-394-6100, and a Public Safety Employee will escort you from any campus building to another.

Flag Pole Across Street

O'HARRA BUILDING – 2ND FLOOR

Campus Emergency Numbers

Emergency 911 (9-911 from a campus phone)

SDSMT Public Safety (605)394-6100

Emergency Information Recording (605)394-2210



SOUTH DAKOTA MINES

An engineering, science and technology university

Building Managers

Angela Mettler
Gina Fiorello
Aaron Grimm, Darrah Steffen

KEY

- You Are Here
- Evacuation Route
- Exit
- Emergency Assembly Point
- Restroom
- Automated External Defibrillator
- Fire Extinguisher
- Fire Alarm (Pull Station)
- Fire Alarm Control Panel
- Fire Sprinkler Shut-off
- Stand Pipe or FDC
- Symbol of Accessibility
- Tornado/Severe Thunderstorm
Refuge Areas
- First Aid Kit
- Eye Wash/Safety Shower
- Spill Kit

In the event of a tornado, please proceed to areas marked on the first floor map.

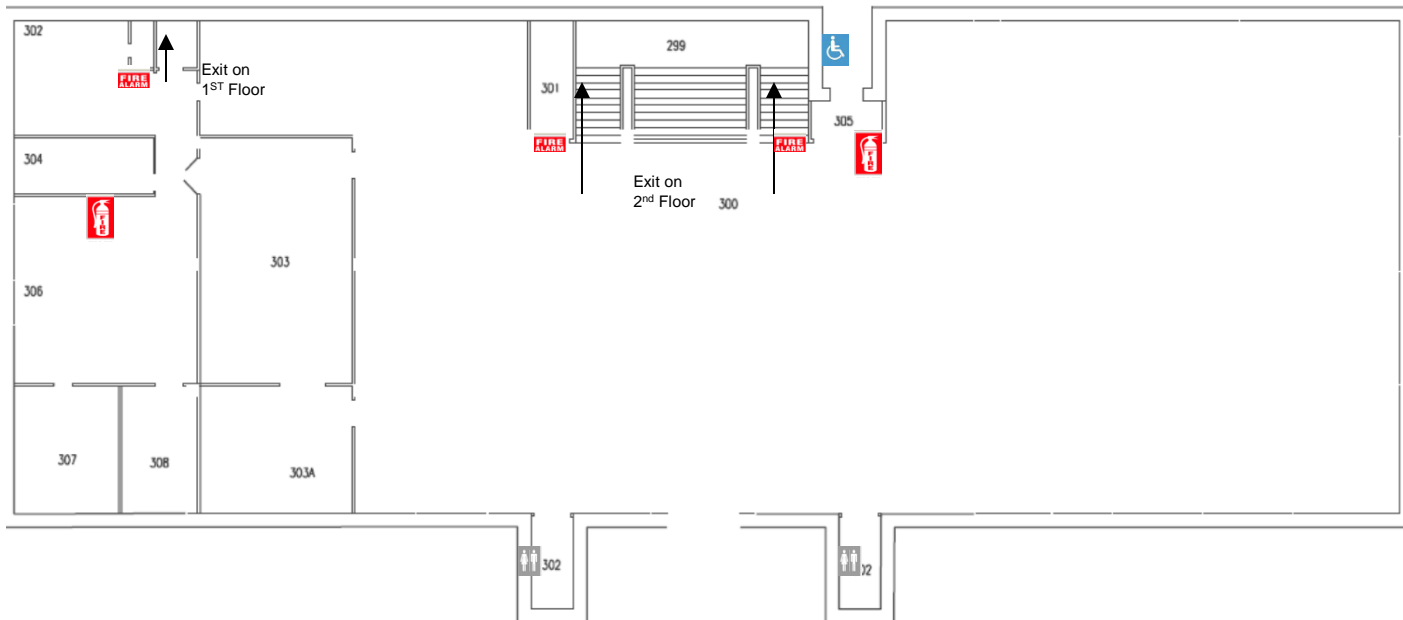

IF THERE IS AN EVACUATION EMERGENCY:

- Assist persons with disabilities
- Exit the building using the nearest exit **DO NOT USE ELEVATORS!**
- Report to the nearest designated area.
- Call 911 (9-911 if on a campus phone)
- Call Public Safety at 605-394-6100
- Do not re-enter until authorized to do so.

CAMPUS ESCORT SERVICE:

Public Safety Provides Escort Services: To arrange an escort, call 605-394-6100, and a Public Safety Employee will escort you from any campus building to another.

Flag Pole Across Street

O'HARRA BUILDING – 3RD FLOOR

Campus Emergency Numbers

Emergency 911 (9-911 from a campus phone)

SDSMT Public Safety (605)394-6100

Emergency Information Recording (605)394-2210



















SOUTH DAKOTA MINES

An engineering, science and technology university

Building Managers

Facility Service needs to assist for emergency. Nonemergency-Haley Armstrong

KEY

-  You Are Here
-  Evacuation Route
-  Exit
-  Emergency Assembly Point
-  Restroom
-  Automated External Defibrillator
-  Fire Extinguisher
-  Fire Alarm (Pull Station)
-  Fire Alarm Control Panel
-  Fire Sprinkler Shut-off
-  Stand Pipe or FDC
-  Symbol of Accessibility
-  Tornado/Severe Thunderstorm Refuge Areas
-  First Aid Kit
-  Eye Wash/Safety Shower
-  Spill Kit

IF THERE IS AN EVACUATION EMERGENCY:

- Assist persons with disabilities
- Exit the building using the nearest exit **DO NOT USE ELEVATORS!**
- Report to the nearest designated area.
- Call 911 (9-911 if on a campus phone)
- Call Public Safety at 605-394-6100
- Do not re-enter until authorized to do so.

CAMPUS ESCORT SERVICE:

Public Safety Provides Escort Services: To arrange an escort, call 605-394-6100, and a Public Safety Employee will escort you from any campus building to another.

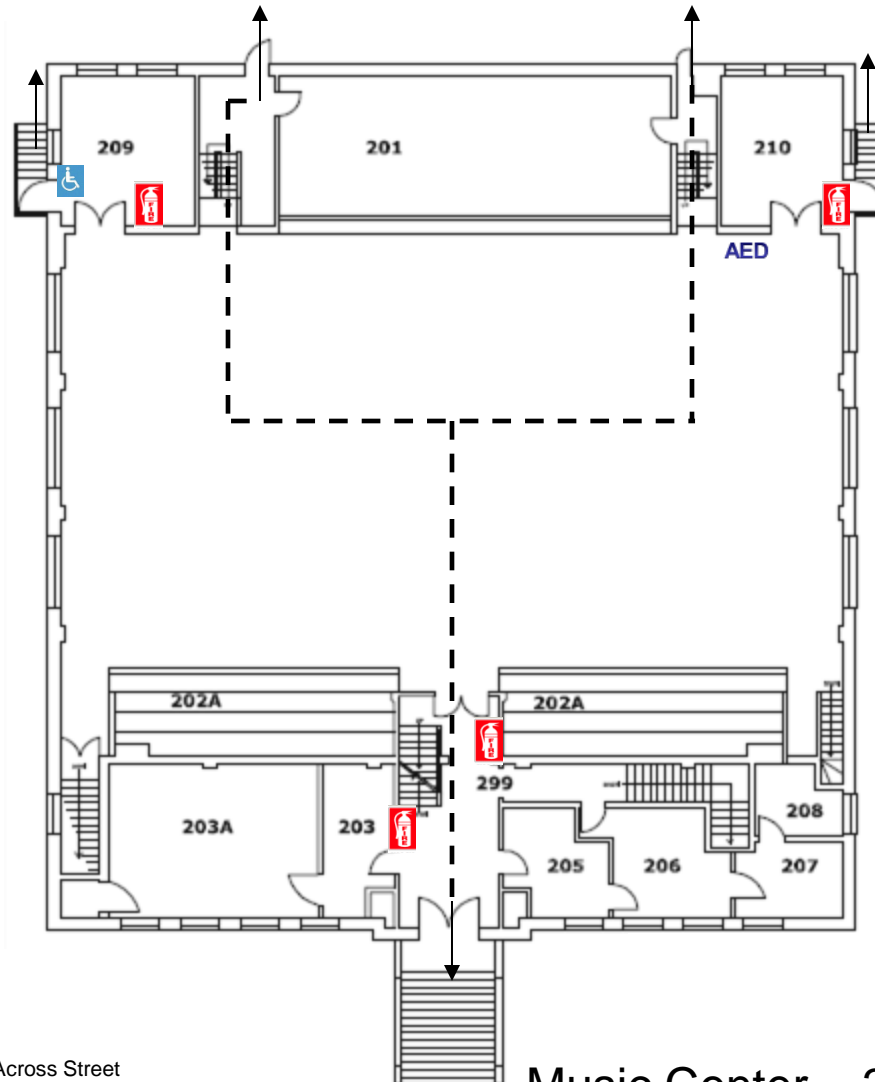

 Flag Pole Across Street

Music Center – 2ND FLOOR

Campus Emergency Numbers

Emergency 911 (9-911 from a campus phone)

SDSMT Public Safety (605)394-6100

Emergency Information Recording (605)394-2210



















SOUTH DAKOTA MINES

An engineering, science and technology university

Building Managers

Facility Service needs to assist for emergency. Nonemergency-Haley Armstrong

KEY

-  You Are Here
-  Evacuation Route
-  Exit
-  Emergency Assembly Point
-  Restroom
-  Automated External Defibrillator
-  Fire Extinguisher
-  Fire Alarm (Pull Station)
-  Fire Alarm Control Panel
-  Fire Sprinkler Shut-off
-  Stand Pipe or FDC
-  Symbol of Accessibility
-  Tornado/Severe Thunderstorm Refuge Areas
-  First Aid Kit
-  Eye Wash/Safety Shower
-  Spill Kit

IF THERE IS AN EVACUATION EMERGENCY:

- Assist persons with disabilities
- Exit the building using the nearest exit **DO NOT USE ELEVATORS!**
- Report to the nearest designated area.
- Call 911 (9-911 if on a campus phone)
- Call Public Safety at 605-394-6100
- Do not re-enter until authorized to do so.

CAMPUS ESCORT SERVICE:

Public Safety Provides Escort Services: To arrange an escort, call 605-394-6100, and a Public Safety Employee will escort you from any campus building to another.

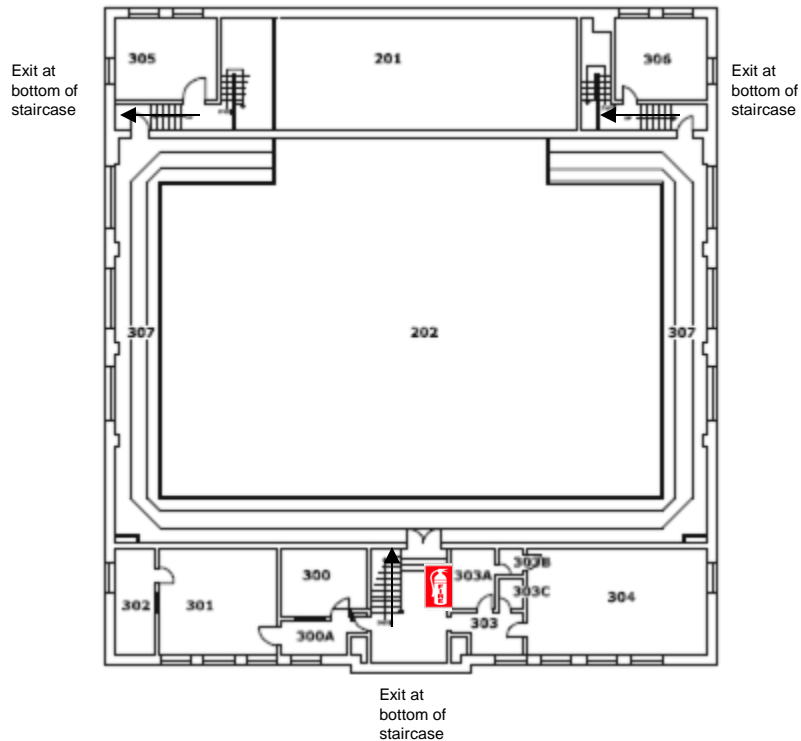
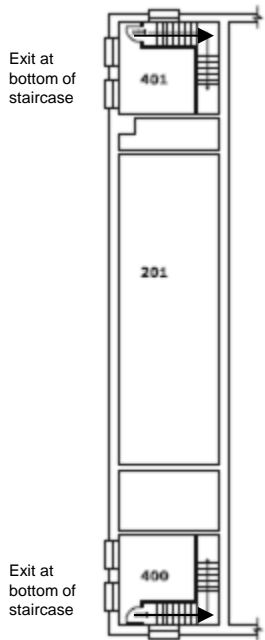

 Flag Pole Across Street

Music Center– 3RD FLOOR

Campus Emergency Numbers

Emergency 911 (9-911 from a campus phone)

SDSMT Public Safety (605)394-6100

Emergency Information Recording (605)394-2210



















SOUTH DAKOTA MINES

An engineering, science and technology university

Building Managers

Katie Wahls
Bryce Nussbaum

KEY

-  You Are Here
-  Evacuation Route
-  Exit
-  Emergency Assembly Point
-  Restroom
-  Automated External Defibrillator
-  Fire Extinguisher
-  Fire Alarm (Pull Station)
-  Fire Alarm Control Panel
-  Fire Sprinkler Shut-off
-  Stand Pipe or FDC
-  Symbol of Accessibility
-  Tornado/Severe Thunderstorm
Refuge Areas
-  First Aid Kit
-  Eye Wash/Safety Shower
-  Spill Kit



The Emergency Assembly Points are located in the March/Dake Plaza and the Civil/Mechanical courtyard area.

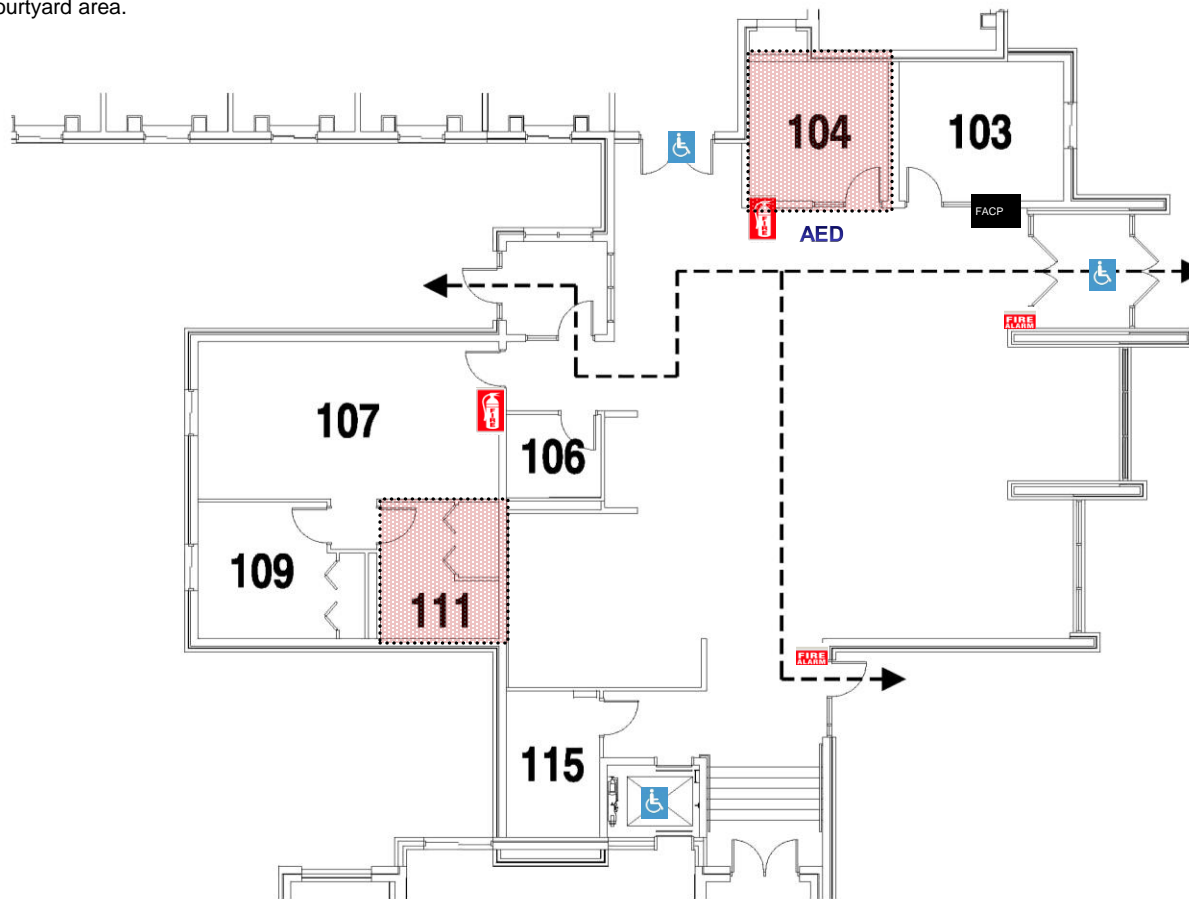

PALMERTON HALL – Commons

IF THERE IS AN EVACUATION EMERGENCY:

- Assist persons with disabilities
- Exit the building using the nearest exit **DO NOT USE ELEVATORS!**
- Report to the nearest designated area.
- Call 911 (9-911 if on a campus phone)
- Call Public Safety at 605-394-6100
- Do not re-enter until authorized to do so.

CAMPUS ESCORT SERVICE:

Public Safety Provides Escort Services: To arrange an escort, call 605-394-6100, and a Public Safety Employee will escort you from any campus building to another.

Campus Emergency Numbers

Emergency 911 (9-911 from a campus phone)

SDSMT Public Safety (605)394-6100

Emergency Information Recording (605)394-2210



















SOUTH DAKOTA MINES

An engineering, science and technology university

Building Managers

Katie Wahls
Bryce Nussbaum

KEY

-  You Are Here
-  Evacuation Route
-  Exit
-  Emergency Assembly Point
-  Restroom
-  Automated External Defibrillator
-  Fire Extinguisher
-  Fire Alarm (Pull Station)
-  Fire Alarm Control Panel
-  Fire Sprinkler Shut-off
-  Stand Pipe or FDC
-  Symbol of Accessibility
-  Tornado/Severe Thunderstorm
Refuge Areas
-  First Aid Kit
-  Eye Wash/Safety Shower
-  Spill Kit



The Emergency Assembly Points are located in the March/Dake Plaza and the Civil/Mechanical courtyard area.

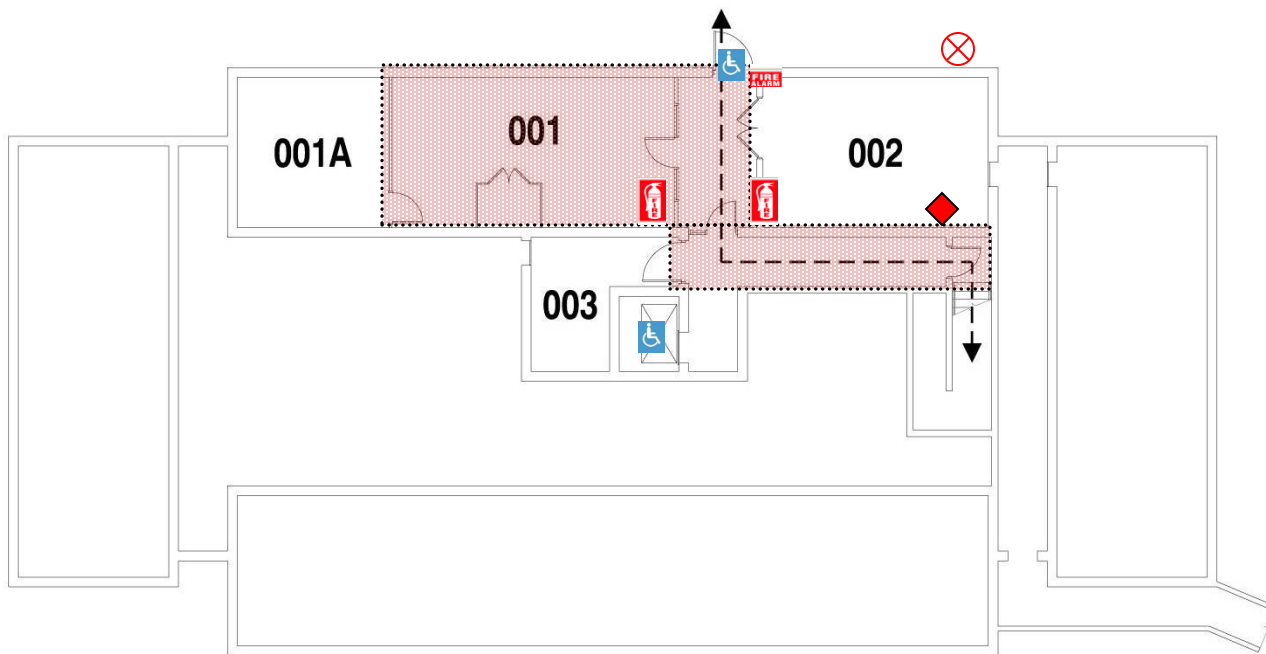

IF THERE IS AN EVACUATION EMERGENCY:

- Assist persons with disabilities
- Exit the building using the nearest exit **DO NOT USE ELEVATORS!**
- Report to the nearest designated area.
- Call 911 (9-911 if on a campus phone)
- Call Public Safety at 605-394-6100
- Do not re-enter until authorized to do so.

CAMPUS ESCORT SERVICE:

Public Safety Provides Escort Services: To arrange an escort, call 605-394-6100, and a Public Safety Employee will escort you from any campus building to another.

PALMERTON HALL – BASEMENT

Campus Emergency Numbers

Emergency 911 (9-911 from a campus phone)

SDSMT Public Safety (605)394-6100

Emergency Information Recording (605)394-2210



SOUTH DAKOTA MINES

An engineering, science and technology university

Building Managers

Katie Wahls
Bryce Nussbaum

KEY

- You Are Here
- Evacuation Route
- Exit
- Emergency Assembly Point
- Restroom
- Automated External Defibrillator
- Fire Extinguisher
- Fire Alarm (Pull Station)
- Fire Alarm Control Panel
- Fire Sprinkler Shut-off
- Stand Pipe or FDC
- Symbol of Accessibility
- Tornado/Severe Thunderstorm Refuge Areas
- First Aid Kit
- Eye Wash/Safety Shower
- Spill Kit

The Emergency Assembly Points are located in the March/Dake Plaza and the Civil/Mechanical courtyard area.

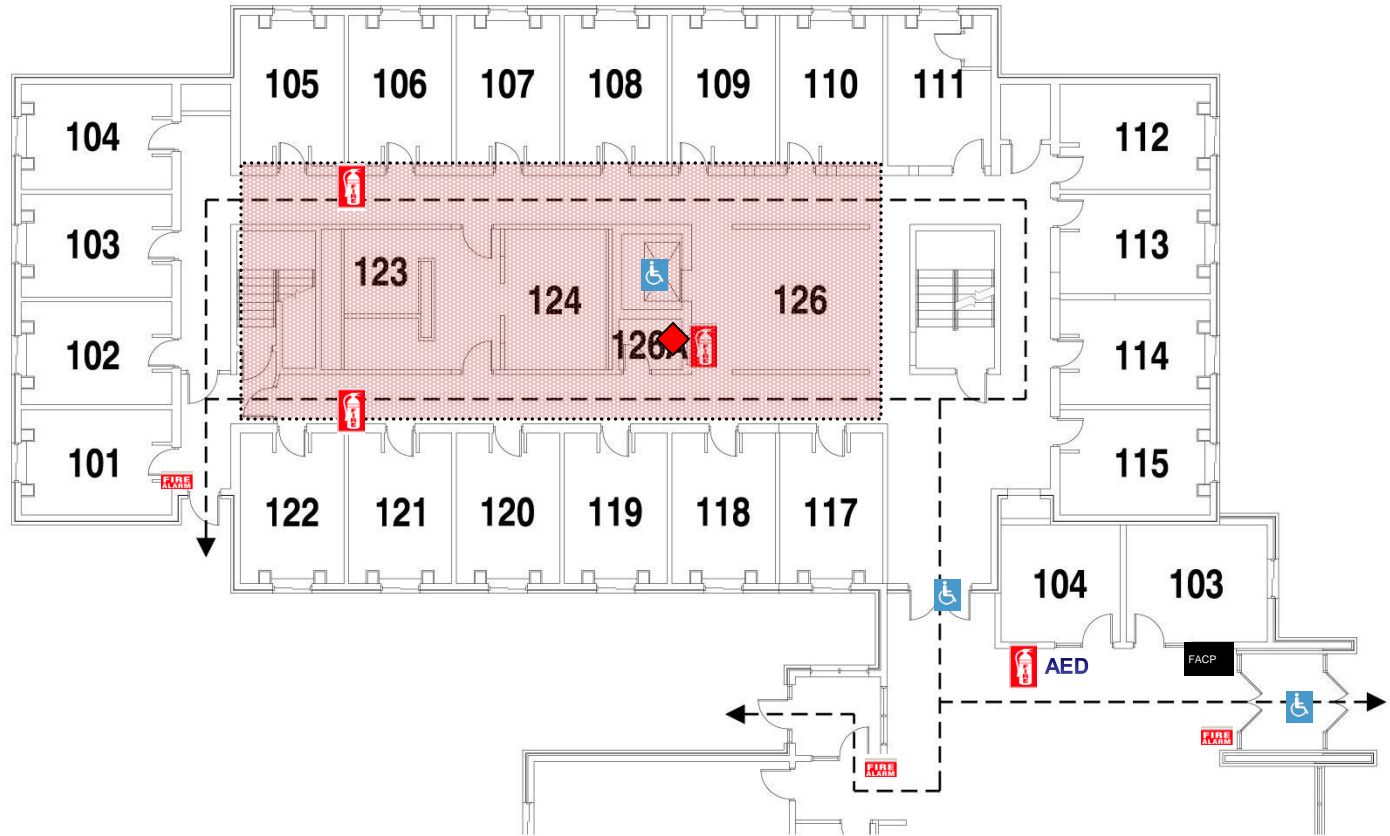

PALMERTON HALL – 1ST FLOOR

IF THERE IS AN EVACUATION EMERGENCY:

- Assist persons with disabilities
- Exit the building using the nearest exit **DO NOT USE ELEVATORS!**
- Report to the nearest designated area.
- Call 911 (9-911 if on a campus phone)
- Call Public Safety at 605-394-6100
- Do not re-enter until authorized to do so.

CAMPUS ESCORT SERVICE:

Public Safety Provides Escort Services: To arrange an escort, call 605-394-6100, and a Public Safety Employee will escort you from any campus building to another.

Campus Emergency Numbers

Emergency 911 (9-911 from a campus phone)

SDSMT Public Safety (605)394-6100

Emergency Information Recording (605)394-2210



SOUTH DAKOTA MINES

An engineering, science and technology university

Building Managers

Katie Wahls
Bryce Nussbaum

KEY

- You Are Here
- Evacuation Route
- Exit
- Emergency Assembly Point
- Restroom
- Automated External Defibrillator
- Fire Extinguisher
- Fire Alarm (Pull Station)
- Fire Alarm Control Panel
- Fire Sprinkler Shut-off
- Stand Pipe or FDC
- Symbol of Accessibility
- Tornado/Severe Thunderstorm Refuge Areas
- First Aid Kit
- Eye Wash/Safety Shower
- Spill Kit

The Emergency Assembly Points are located in the March/Dake Plaza and the Civil/Mechanical courtyard area.

In the event of a tornado, please proceed to areas marked on the commons, basement, and first floor map.

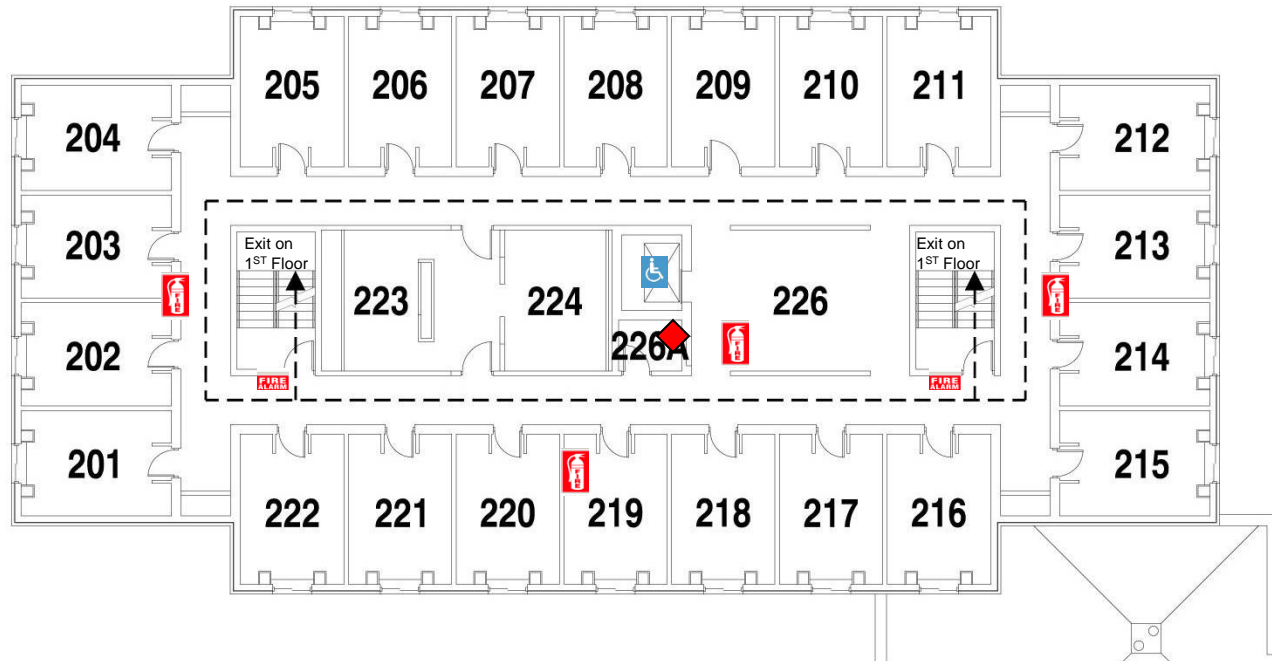

IF THERE IS AN EVACUATION EMERGENCY:

- Assist persons with disabilities
- Exit the building using the nearest exit DO NOT USE ELEVATORS!
- Report to the nearest designated area.
- Call 911 (9-911 if on a campus phone)
- Call Public Safety at 605-394-6100
- Do not re-enter until authorized to do so.

CAMPUS ESCORT SERVICE:

Public Safety Provides Escort Services: To arrange an escort, call 605-394-6100, and a Public Safety Employee will escort you from any campus building to another.

PALMERTON HALL – 2ND FLOOR

Campus Emergency Numbers

Emergency 911 (9-911 from a campus phone)

SDSMT Public Safety (605)394-6100

Emergency Information Recording (605)394-2210



SOUTH DAKOTA MINES

An engineering, science and technology university

Building Managers

Katie Wahls
Bryce Nussbaum

KEY

- You Are Here
- Evacuation Route
- Exit
- Emergency Assembly Point
- Restroom
- Automated External Defibrillator
- Fire Extinguisher
- Fire Alarm (Pull Station)
- Fire Alarm Control Panel
- Fire Sprinkler Shut-off
- Stand Pipe or FDC
- Symbol of Accessibility
- Tornado/Severe Thunderstorm
Refuge Areas
- First Aid Kit
- Eye Wash/Safety Shower
- Spill Kit



The Emergency Assembly Points are located in the March/Dake Plaza and the Civil/Mechanical courtyard area.

In the event of a tornado, please proceed to areas marked on the commons, basement, and first floor map.

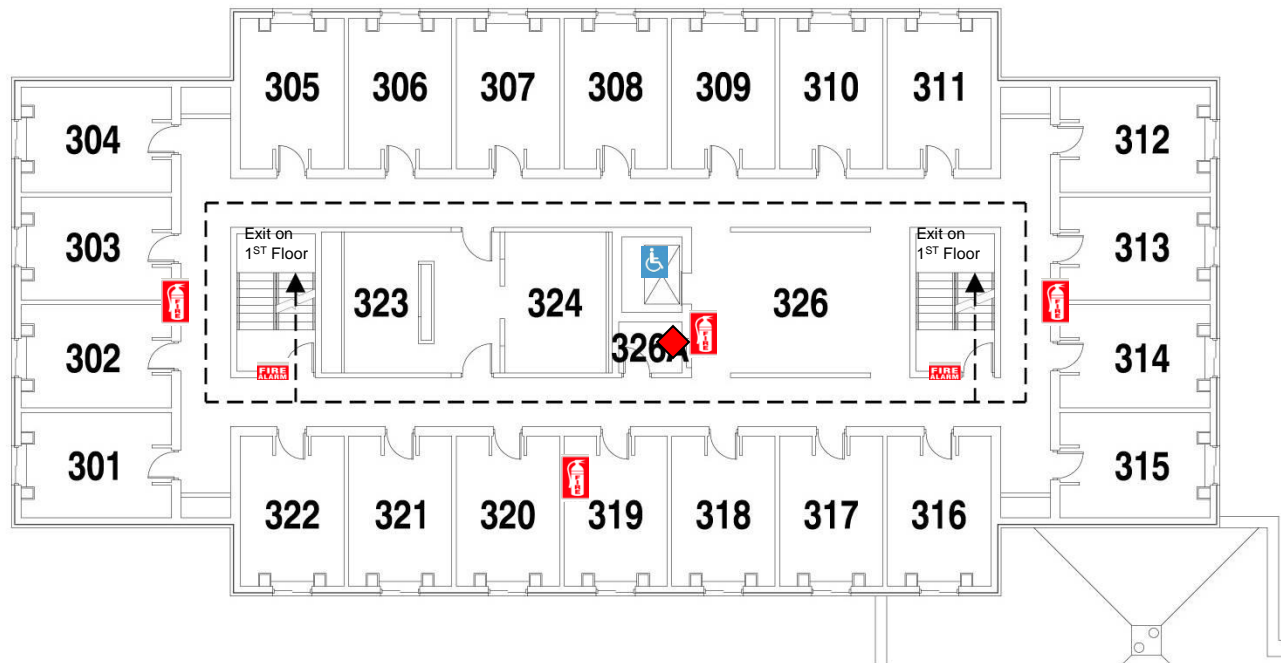

PALMERTON HALL – 3RD FLOOR

IF THERE IS AN EVACUATION EMERGENCY:

- Assist persons with disabilities
- Exit the building using the nearest exit **DO NOT USE ELEVATORS!**
- Report to the nearest designated area.
- Call 911 (9-911 if on a campus phone)
- Call Public Safety at 605-394-6100
- Do not re-enter until authorized to do so.

CAMPUS ESCORT SERVICE:

Public Safety Provides Escort Services: To arrange an escort, call 605-394-6100, and a Public Safety Employee will escort you from any campus building to another.

Campus Emergency Numbers

Emergency 911 (9-911 from a campus phone)

SDSMT Public Safety (605)394-6100

Emergency Information Recording (605)394-2210



SOUTH DAKOTA MINES

An engineering, science and technology university

Building Managers

Katie Wahls
Bryce Nussbaum

KEY

- You Are Here
- Evacuation Route
- Exit
- Emergency Assembly Point
- Restroom
- Automated External Defibrillator
- Fire Extinguisher
- Fire Alarm (Pull Station)
- Fire Alarm Control Panel
- Fire Sprinkler Shut-off
- Stand Pipe or FDC
- Symbol of Accessibility
- Tornado/Severe Thunderstorm
Refuge Areas
- First Aid Kit
- Eye Wash/Safety Shower
- Spill Kit



The Emergency Assembly Points are located in the March/Dake Plaza and the Civil/Mechanical courtyard area.



In the event of a tornado, please proceed to areas marked on the commons, basement, and first floor map.

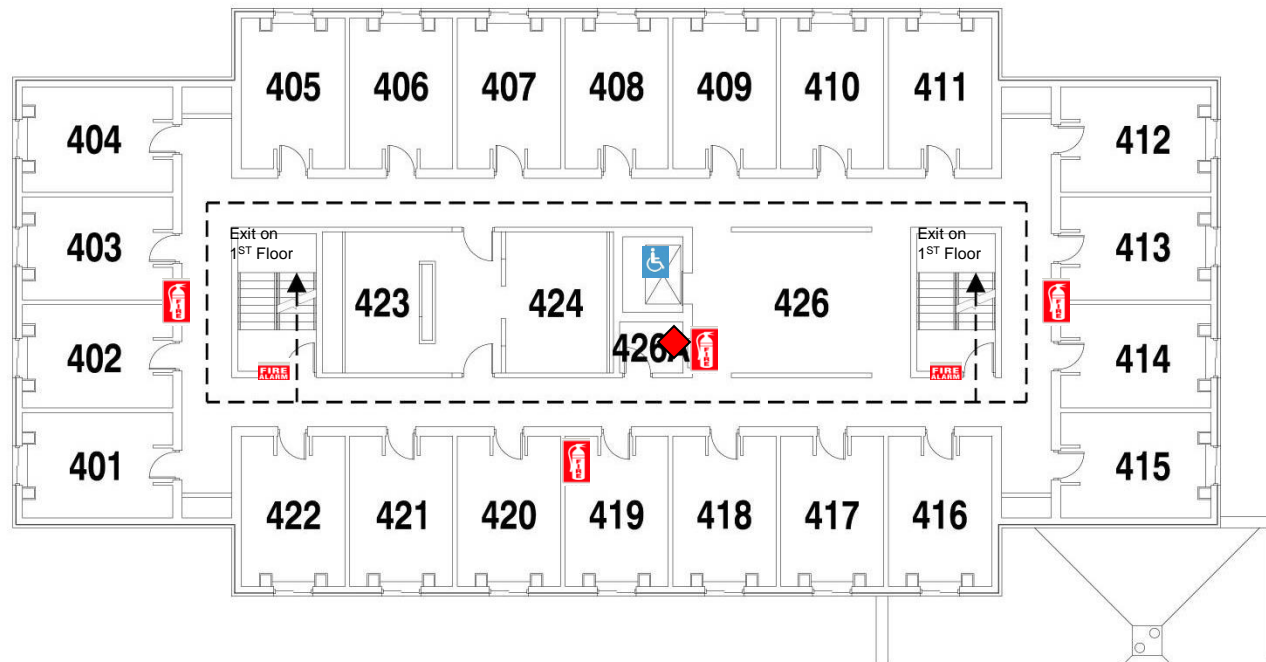

IF THERE IS AN EVACUATION EMERGENCY:

- Assist persons with disabilities
- Exit the building using the nearest exit **DO NOT USE ELEVATORS!**
- Report to the nearest designated area.
- Call 911 (9-911 if on a campus phone)
- Call Public Safety at 605-394-6100
- Do not re-enter until authorized to do so.

CAMPUS ESCORT SERVICE:

Public Safety Provides Escort Services: To arrange an escort, call 605-394-6100, and a Public Safety Employee will escort you from any campus building to another.

PALMERTON HALL – 4TH FLOOR

Campus Emergency Numbers

Emergency 911 (9-911 from a campus phone)

SDSM&T Public Safety (605)394-6100

Emergency Information Recording (605)394-2210



SOUTH DAKOTA MINES

An engineering, science and technology university

Building Managers

Katie Wahls
Bryce Nussbaum

KEY

- You Are Here
- Evacuation Route
- Exit
- Emergency Assembly Point
- Restroom
- Automated External Defibrillator
- Fire Extinguisher
- Fire Alarm (Pull Station)
- Fire Alarm Control Panel
- Fire Sprinkler Shut-off
- Stand Pipe or FDC
- Symbol of Accessibility
- Tornado/Severe Thunderstorm
Refuge Areas
- First Aid Kit
- Eye Wash/Safety Shower
- Spill Kit

The Emergency Assembly Points are located in the March/Dake Plaza and the Civil/Mechanical courtyard area.



In the event of a tornado, please proceed to areas marked on the commons, basement, and first floor map.

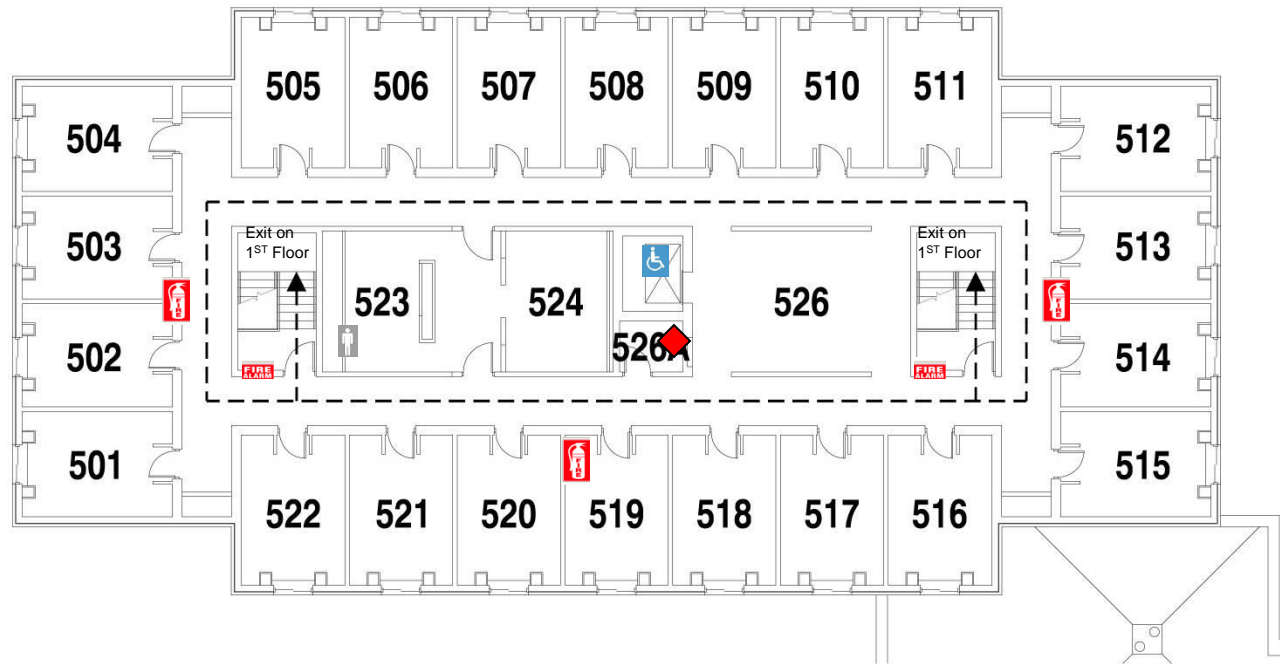

IF THERE IS AN EVACUATION EMERGENCY:

- Assist persons with disabilities
- Exit the building using the nearest exit **DO NOT USE ELEVATORS!**
- Report to the nearest designated area.
- Call 911 (9-911 if on a campus phone)
- Call Public Safety at 605-394-6100
- Do not re-enter until authorized to do so.

CAMPUS ESCORT SERVICE:

Public Safety Provides Escort Services: To arrange an escort, call 605-394-6100, and a Public Safety Employee will escort you from any campus building to another.

PALMERTON HALL – 5TH FLOOR

Campus Emergency Numbers

Emergency 911 (9-911 from a campus phone)

SDSM&T Public Safety (605)394-6100

Emergency Information Recording (605)394-2210



SOUTH DAKOTA MINES

An engineering, science and technology university

Building Managers

Katie Wahls
Bryce Nussbaum

KEY

- You Are Here
- Evacuation Route
- Exit
- Emergency Assembly Point
- Restroom
- Automated External Defibrillator
- Fire Extinguisher
- Fire Alarm (Pull Station)
- Fire Alarm Control Panel
- Fire Sprinkler Shut-off
- Stand Pipe or FDC
- Symbol of Accessibility
- Tornado/Severe Thunderstorm
Refuge Areas
- First Aid Kit
- Eye Wash/Safety Shower
- Spill Kit

In the event of a tornado, please proceed to areas marked on the first floor map.



IF THERE IS AN EVACUATION EMERGENCY:

- Assist persons with disabilities
- Exit the building using the nearest exit **DO NOT USE ELEVATORS!**
- Report to the nearest designated area.
- Call 911 (9-911 if on a campus phone)
- Call Public Safety at 605-394-6100
- Do not re-enter until authorized to do so.

CAMPUS ESCORT SERVICE:

Public Safety Provides Escort Services: To arrange an escort, call 605-394-6100, and a Public Safety Employee will escort you from any campus building to another.

Placer Hall – 1st Floor

Campus Emergency Numbers

Emergency 911 (9-911 from a campus phone)

SDSMT Public Safety (605)394-6100

Emergency Information Recording (605)394-2210



















SOUTH DAKOTA MINES

An engineering, science and technology university

Building Managers

Katie Wahls
Bryce Nussbaum

KEY

-  You Are Here
-  Evacuation Route
-  Exit
-  Emergency Assembly Point
-  Restroom
-  Automated External Defibrillator
-  Fire Extinguisher
-  Fire Alarm (Pull Station)
-  Fire Alarm Control Panel
-  Fire Sprinkler Shut-off
-  Stand Pipe or FDC
-  Symbol of Accessibility
-  Tornado/Severe Thunderstorm
Refuge Areas
-  First Aid Kit
-  Eye Wash/Safety Shower
-  Spill Kit

In the event of a tornado, please proceed to areas marked on the first floor map.



IF THERE IS AN EVACUATION EMERGENCY:

- Assist persons with disabilities
- Exit the building using the nearest exit **DO NOT USE ELEVATORS!**
- Report to the nearest designated area.
- Call 911 (9-911 if on a campus phone)
- Call Public Safety at 605-394-6100
- Do not re-enter until authorized to do so.

CAMPUS ESCORT SERVICE:

Public Safety Provides Escort Services: To arrange an escort, call 605-394-6100, and a Public Safety Employee will escort you from any campus building to another.

Placer Hall – 2nd, 3rd, 5th Floors

Campus Emergency Numbers

Emergency 911 (9-911 from a campus phone)

SDSMT Public Safety (605)394-6100

Emergency Information Recording (605)394-2210



SOUTH DAKOTA MINES

An engineering, science and technology university

Building Managers

Katie Wahls
Bryce Nussbaum

KEY

- You Are Here
- Evacuation Route
- Exit
- Emergency Assembly Point
- Restroom
- Automated External Defibrillator
- Fire Extinguisher
- Fire Alarm (Pull Station)
- Fire Alarm Control Panel
- Fire Sprinkler Shut-off
- Stand Pipe or FDC
- Symbol of Accessibility
- Tornado/Severe Thunderstorm
Refuge Areas
- First Aid Kit
- Eye Wash/Safety Shower
- Spill Kit

In the event of a tornado, please proceed to areas marked on the first floor map.



IF THERE IS AN EVACUATION EMERGENCY:

- Assist persons with disabilities
- Exit the building using the nearest exit **DO NOT USE ELEVATORS!**
- Report to the nearest designated area.
- Call 911 (9-911 if on a campus phone)
- Call Public Safety at 605-394-6100
- Do not re-enter until authorized to do so.

CAMPUS ESCORT SERVICE:

Public Safety Provides Escort Services: To arrange an escort, call 605-394-6100, and a Public Safety Employee will escort you from any campus building to another.

Placer Hall – 3rd Floor

Campus Emergency Numbers

Emergency 911 (9-911 from a campus phone)

SDSMT Public Safety (605)394-6100

Emergency Information Recording (605)394-2210



















SOUTH DAKOTA MINES

An engineering, science and technology university

Building Managers

Katie Wahls
Bryce Nussbaum

KEY

-  You Are Here
-  Evacuation Route
-  Exit
-  Emergency Assembly Point
-  Restroom
-  Automated External Defibrillator
-  Fire Extinguisher
-  Fire Alarm (Pull Station)
-  Fire Alarm Control Panel
-  Fire Sprinkler Shut-off
-  Stand Pipe or FDC
-  Symbol of Accessibility
-  Tornado/Severe Thunderstorm
Refuge Areas
-  First Aid Kit
-  Eye Wash/Safety Shower
-  Spill Kit

In the event of a tornado, please proceed to areas marked on the first floor map.



IF THERE IS AN EVACUATION EMERGENCY:

- Assist persons with disabilities
- Exit the building using the nearest exit **DO NOT USE ELEVATORS!**
- Report to the nearest designated area.
- Call 911 (9-911 if on a campus phone)
- Call Public Safety at 605-394-6100
- Do not re-enter until authorized to do so.

CAMPUS ESCORT SERVICE:

Public Safety Provides Escort Services: To arrange an escort, call 605-394-6100, and a Public Safety Employee will escort you from any campus building to another.

Placer Hall – 4th and 6th Floors

Campus Emergency Numbers

Emergency 911 (9-911 from a campus phone)

SDSM&T Public Safety (605)394-6100

Emergency Information Recording (605)394-2210



SOUTH DAKOTA MINES

An engineering, science and technology university

Building Managers

Katie Wahls
Bryce Nussbaum

KEY

- You Are Here
- Evacuation Route
- Exit
- Emergency Assembly Point

In the event of a tornado, please proceed to areas marked on the first floor map.

- Restroom
- Automated External Defibrillator
- Fire Extinguisher
- Fire Alarm (Pull Station)
- Fire Alarm Control Panel
- Fire Sprinkler Shut-off

- Stand Pipe or FDC
- Symbol of Accessibility
- Tornado/Severe Thunderstorm Refuge Areas
- First Aid Kit
- Eye Wash/Safety Shower
- Spill Kit



IF THERE IS AN EVACUATION EMERGENCY:

- Assist persons with disabilities
- Exit the building using the nearest exit **DO NOT USE ELEVATORS!**
- Report to the nearest designated area.
- Call 911 (9-911 if on a campus phone)
- Call Public Safety at 605-394-6100
- Do not re-enter until authorized to do so.

CAMPUS ESCORT SERVICE:

Public Safety Provides Escort Services: To arrange an escort, call 605-394-6100, and a Public Safety Employee will escort you from any campus building to another.

Placer Hall – 5th Floor

Campus Emergency Numbers

Emergency 911 (9-911 from a campus phone)

SDSMT Public Safety (605)394-6100

Emergency Information Recording (605)394-2210



SOUTH DAKOTA MINES

An engineering, science and technology university

Building Managers

Katie Wahls
Bryce Nussbaum

KEY

- You Are Here
- Evacuation Route
- Exit
- Emergency Assembly Point

In the event of a tornado, please proceed to areas marked on the first floor map.



- Restroom
- Automated External Defibrillator
- Fire Extinguisher
- Fire Alarm (Pull Station)
- Fire Alarm Control Panel
- Fire Sprinkler Shut-off
- Stand Pipe or FDC
- Symbol of Accessibility
- Tornado/Severe Thunderstorm Refuge Areas
- First Aid Kit
- Eye Wash/Safety Shower
- Spill Kit

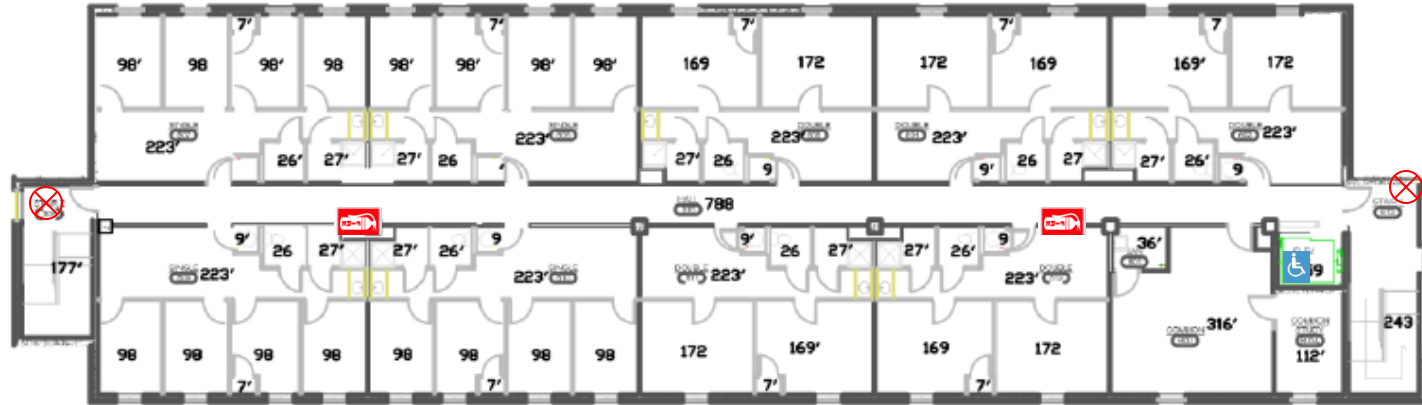

IF THERE IS AN EVACUATION EMERGENCY:

- Assist persons with disabilities
- Exit the building using the nearest exit **DO NOT USE ELEVATORS!**
- Report to the nearest designated area.
- Call 911 (9-911 if on a campus phone)
- Call Public Safety at 605-394-6100
- Do not re-enter until authorized to do so.

CAMPUS ESCORT SERVICE:

Public Safety Provides Escort Services: To arrange an escort, call 605-394-6100, and a Public Safety Employee will escort you from any campus building to another.

Placer Hall – 6th Floor

Campus Emergency Numbers

Emergency 911 (9-911 from a campus phone)

SDSMT Public Safety (605)394-6100

Emergency Information Recording (605)394-2210

Building Managers

















Katie Wahls
Bryce Nussbaum



SOUTH DAKOTA MINES

An engineering, science and technology university

KEY

-  You Are Here
-  Evacuation Route
-  Exit
-  Emergency Assembly Point
-  Restroom
-  Automated External Defibrillator
-  Fire Extinguisher
-  Fire Alarm (Pull Station)
-  Fire Alarm Control Panel
-  Fire Sprinkler Shut-off
-  Stand Pipe or FDC
-  Symbol of Accessibility
-  Tornado/Severe Thunderstorm
Refuge Areas
-  First Aid Kit
-  Eye Wash/Safety Shower
-  Spill Kit

In the event of a tornado, please proceed to areas marked on the first floor map.

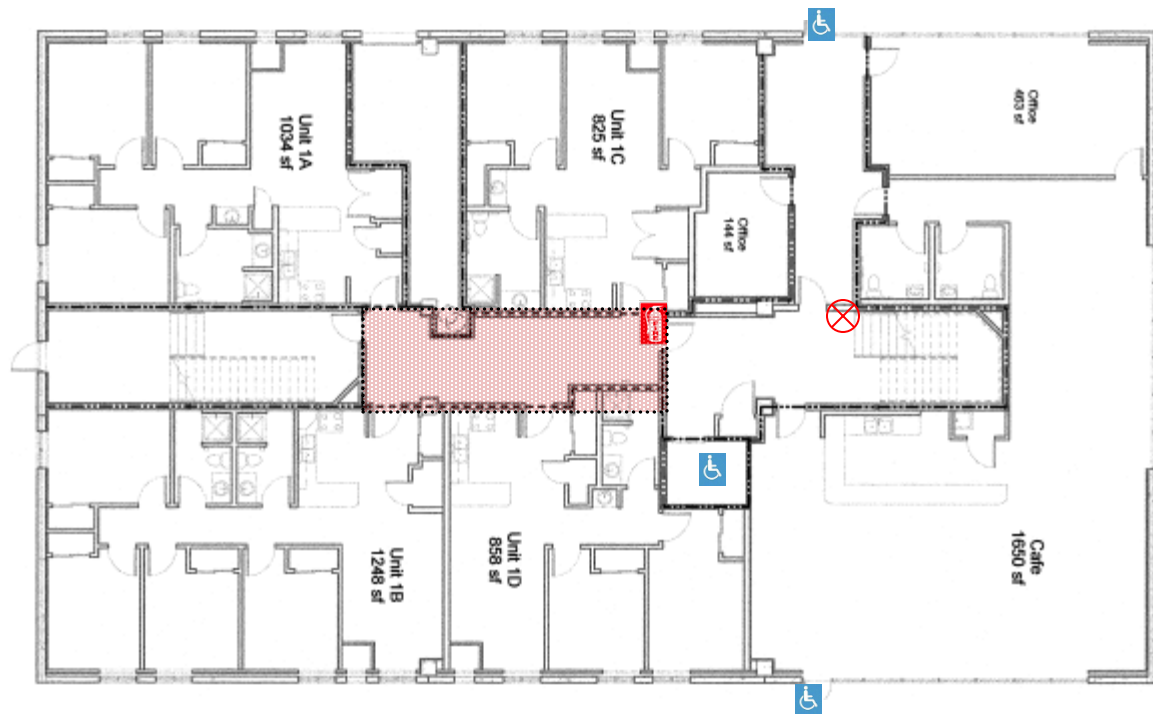

IF THERE IS AN EVACUATION EMERGENCY:

- Assist persons with disabilities
- Exit the building using the nearest exit **DO NOT USE ELEVATORS!**
- Report to the nearest designated area.
- Call 911 (9-911 if on a campus phone)
- Call Public Safety at 605-394-6100
- Do not re-enter until authorized to do so.

CAMPUS ESCORT SERVICE:

Public Safety Provides Escort Services: To arrange an escort, call 605-394-6100, and a Public Safety Employee will escort you from any campus building to another.

Rocker Square 1 – 1st Floor

Campus Emergency Numbers

Emergency 911 (9-911 from a campus phone)

SDSMT Public Safety (605)394-6100

Emergency Information Recording (605)394-2210



















SOUTH DAKOTA MINES

An engineering, science and technology university

Building Managers

Katie Wahls
Bryce Nussbaum

KEY

-  You Are Here
-  Evacuation Route
-  Exit
-  Emergency Assembly Point
-  Restroom
-  Automated External Defibrillator
-  Fire Extinguisher
-  Fire Alarm (Pull Station)
-  Fire Alarm Control Panel
-  Fire Sprinkler Shut-off
-  Stand Pipe or FDC
-  Symbol of Accessibility
-  Tornado/Severe Thunderstorm
Refuge Areas
-  First Aid Kit
-  Eye Wash/Safety Shower
-  Spill Kit

In the event of a tornado, please proceed to areas marked on the first floor map.



IF THERE IS AN EVACUATION EMERGENCY:

- Assist persons with disabilities
- Exit the building using the nearest exit DO NOT USE ELEVATORS!
- Report to the nearest designated area.
- Call 911 (9-911 if on a campus phone)
- Call Public Safety at 605-394-6100
- Do not re-enter until authorized to do so.

CAMPUS ESCORT SERVICE:

Public Safety Provides Escort Services: To arrange an escort, call 605-394-6100, and a Public Safety Employee will escort you from any campus building to another.

Rucker Square 1 – 2nd through 6th Floor

Campus Emergency Numbers

Emergency 911 (9-911 from a campus phone)

SDSMT Public Safety (605)394-6100

Emergency Information Recording (605)394-2210



















SOUTH DAKOTA MINES

An engineering, science and technology university

Building Managers

Katie Wahls
Bryce Nussbaum

KEY

-  You Are Here
-  Evacuation Route
-  Exit
-  Emergency Assembly Point
-  Restroom
-  Automated External Defibrillator
-  Fire Extinguisher
-  Fire Alarm (Pull Station)
-  Fire Alarm Control Panel
-  Fire Sprinkler Shut-off
-  Stand Pipe or FDC
-  Symbol of Accessibility
-  Tornado/Severe Thunderstorm
Refuge Areas
-  First Aid Kit
-  Eye Wash/Safety Shower
-  Spill Kit

In the event of a tornado, please proceed to areas marked on the first floor map.

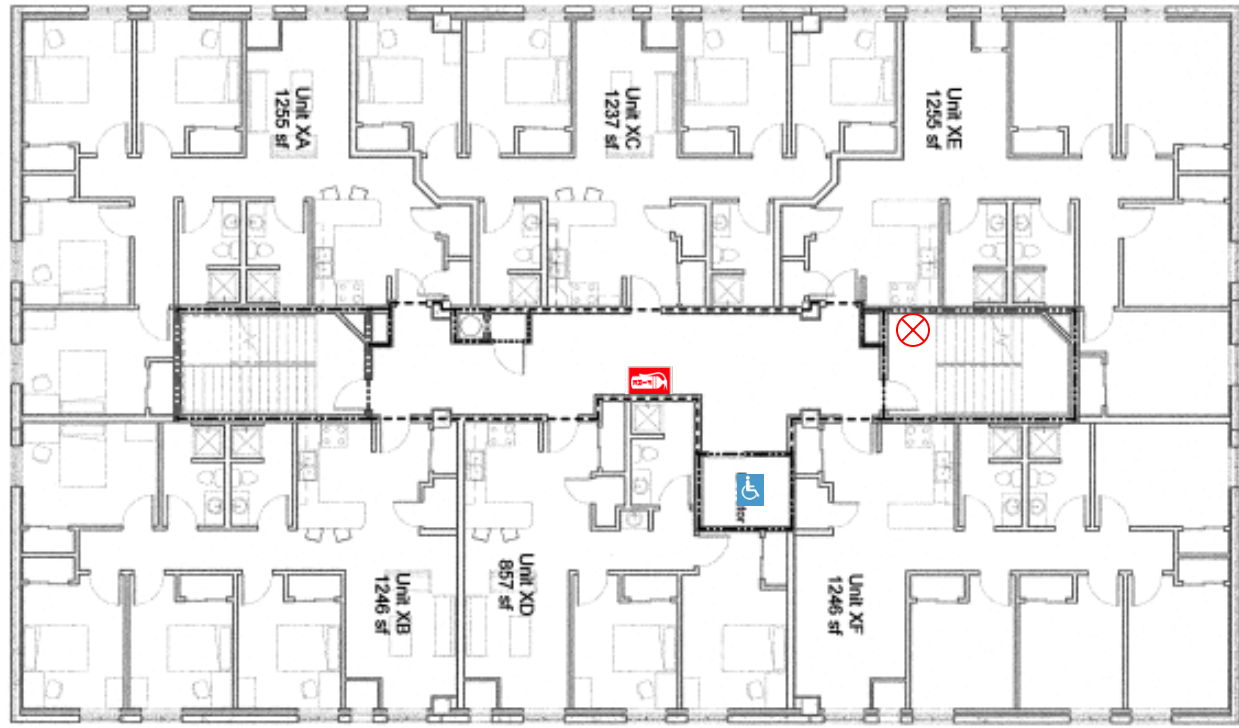

IF THERE IS AN EVACUATION EMERGENCY:

- Assist persons with disabilities
- Exit the building using the nearest exit **DO NOT USE ELEVATORS!**
- Report to the nearest designated area.
- Call 911 (9-911 if on a campus phone)
- Call Public Safety at 605-394-6100
- Do not re-enter until authorized to do so.

CAMPUS ESCORT SERVICE:

Public Safety Provides Escort Services: To arrange an escort, call 605-394-6100, and a Public Safety Employee will escort you from any campus building to another.

Rocker Square 1 – 3rd Floor

Campus Emergency Numbers

Emergency 911 (9-911 from a campus phone)

SDSMT Public Safety (605)394-6100

Emergency Information Recording (605)394-2210



SOUTH DAKOTA MINES

An engineering, science and technology university

Building Managers

Katie Wahls
Bryce Nussbaum

KEY

- You Are Here
- Evacuation Route
- Exit
- Emergency Assembly Point
- Restroom
- AED Automated External Defibrillator
- Fire Extinguisher
- Fire Alarm (Pull Station)
- Fire Alarm Control Panel
- Fire Sprinkler Shut-off
- Stand Pipe or FDC
- Symbol of Accessibility
- Tornado/Severe Thunderstorm Refuge Areas
- First Aid Kit
- Eye Wash/Safety Shower
- Spill Kit

In the event of a tornado, please proceed to areas marked on the first floor map.

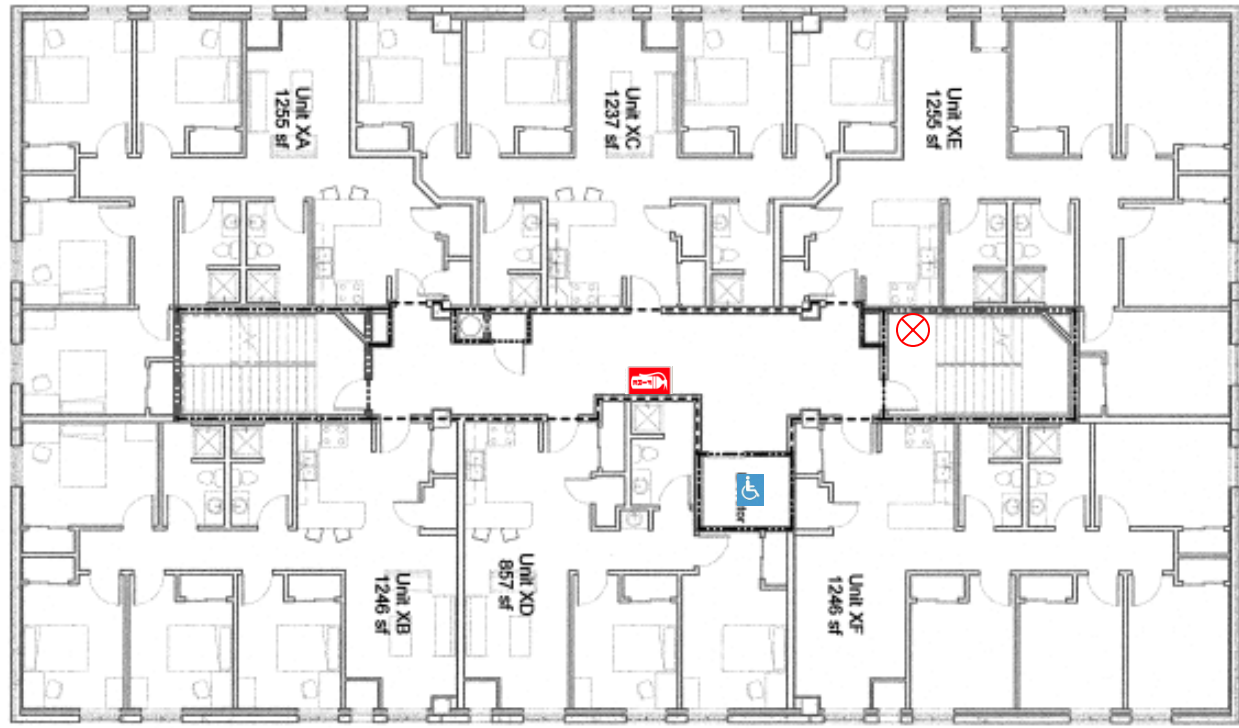

IF THERE IS AN EVACUATION EMERGENCY:

- Assist persons with disabilities
- Exit the building using the nearest exit DO NOT USE ELEVATORS!
- Report to the nearest designated area.
- Call 911 (9-911 if on a campus phone)
- Call Public Safety at 605-394-6100
- Do not re-enter until authorized to do so.

CAMPUS ESCORT SERVICE:

Public Safety Provides Escort Services: To arrange an escort, call 605-394-6100, and a Public Safety Employee will escort you from any campus building to another.

Rocker Square 1 – 4th Floor

Campus Emergency Numbers

Emergency 911 (9-911 from a campus phone)

SDSMT Public Safety (605)394-6100

Emergency Information Recording (605)394-2210



SOUTH DAKOTA MINES

An engineering, science and technology university

Building Managers

Katie Wahls
Bryce Nussbaum

KEY

- You Are Here
- Evacuation Route
- Exit
- Emergency Assembly Point
- Restroom
- AED Automated External Defibrillator
- Fire Extinguisher
- Fire Alarm (Pull Station)
- Fire Alarm Control Panel
- Fire Sprinkler Shut-off
- Stand Pipe or FDC
- Symbol of Accessibility
- Tornado/Severe Thunderstorm
Refuge Areas
- First Aid Kit
- Eye Wash/Safety Shower
- Spill Kit

In the event of a tornado, please proceed to areas marked on the first floor map.

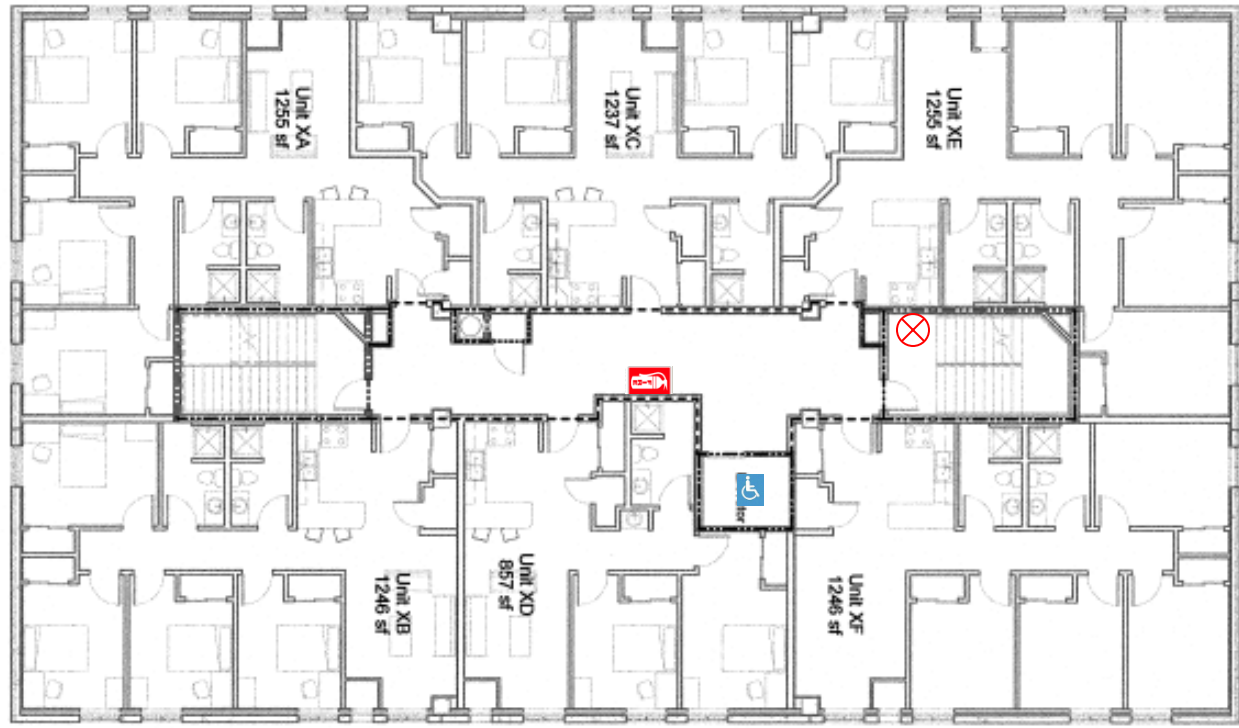

IF THERE IS AN EVACUATION EMERGENCY:

- Assist persons with disabilities
- Exit the building using the nearest exit DO NOT USE ELEVATORS!
- Report to the nearest designated area.
- Call 911 (9-911 if on a campus phone)
- Call Public Safety at 605-394-6100
- Do not re-enter until authorized to do so.

CAMPUS ESCORT SERVICE:

Public Safety Provides Escort Services: To arrange an escort, call 605-394-6100, and a Public Safety Employee will escort you from any campus building to another.

Rocker Square 1 – 5th Floor

Campus Emergency Numbers

Emergency 911 (9-911 from a campus phone)

SDSMT Public Safety (605)394-6100

Emergency Information Recording (605)394-2210



















SOUTH DAKOTA MINES

An engineering, science and technology university

Building Managers

Katie Wahls
Bryce Nussbaum

KEY

-  You Are Here
-  Evacuation Route
-  Exit
-  Emergency Assembly Point
-  Restroom
-  AED Automated External Defibrillator
-  Fire Extinguisher
-  Fire Alarm (Pull Station)
-  FACP Fire Alarm Control Panel
-  Fire Sprinkler Shut-off
-  Stand Pipe or FDC
-  Symbol of Accessibility
-  Tornado/Severe Thunderstorm
Refuge Areas
-  First Aid Kit
-  Eye Wash/Safety Shower
-  Spill Kit

In the event of a tornado, please proceed to areas marked on the first floor map.

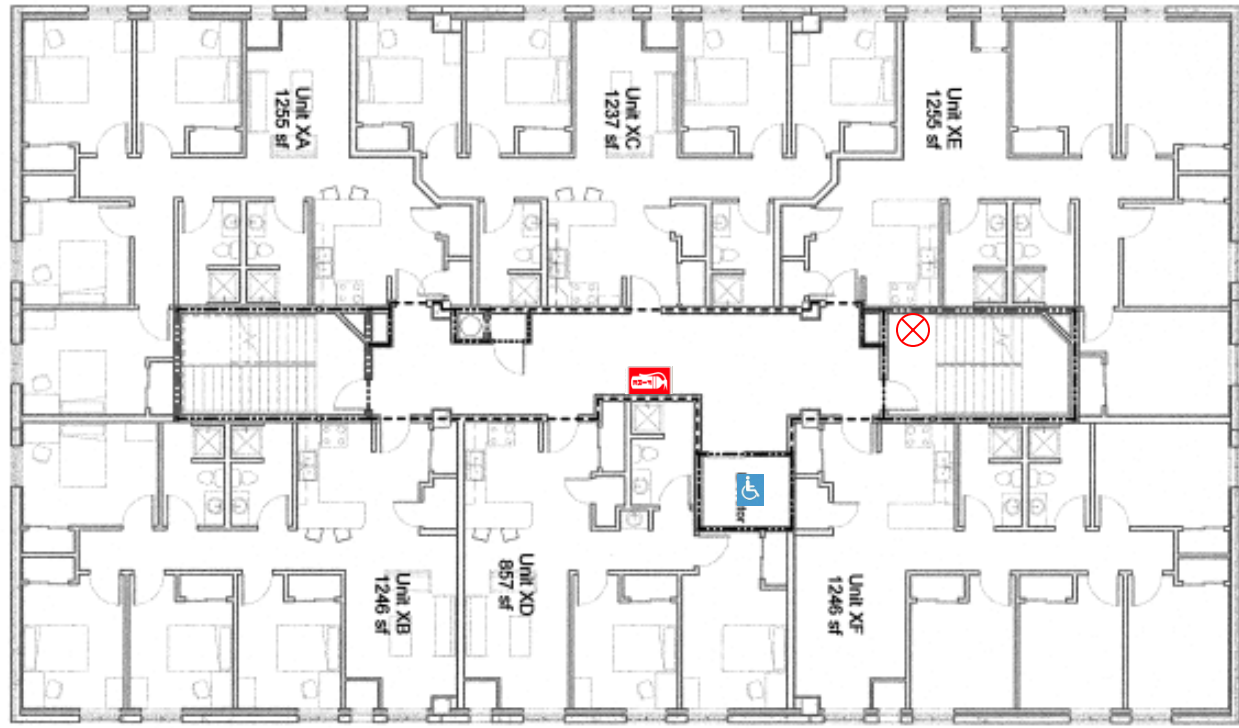

IF THERE IS AN EVACUATION EMERGENCY:

- Assist persons with disabilities
- Exit the building using the nearest exit DO NOT USE ELEVATORS!
- Report to the nearest designated area.
- Call 911 (9-911 if on a campus phone)
- Call Public Safety at 605-394-6100
- Do not re-enter until authorized to do so.

CAMPUS ESCORT SERVICE:

Public Safety Provides Escort Services: To arrange an escort, call 605-394-6100, and a Public Safety Employee will escort you from any campus building to another.

Rocker Square 1 – 6th Floor

Campus Emergency Numbers

Emergency 911 (9-911 from a campus phone)

SDSMT Public Safety (605)394-6100

Emergency Information Recording (605)394-2210



















SOUTH DAKOTA MINES

An engineering, science and technology university

Building Managers

Katie Wahls
Bryce Nussbaum

KEY

-  You Are Here
-  Evacuation Route
-  Exit
-  Emergency Assembly Point
-  Restroom
-  Automated External Defibrillator
-  Fire Extinguisher
-  Fire Alarm (Pull Station)
-  Fire Alarm Control Panel
-  Fire Sprinkler Shut-off
-  Stand Pipe or FDC
-  Symbol of Accessibility
-  Tornado/Severe Thunderstorm
Refuge Areas
-  First Aid Kit
-  Eye Wash/Safety Shower
-  Spill Kit

In the event of a tornado, please proceed to areas marked on the first floor map.

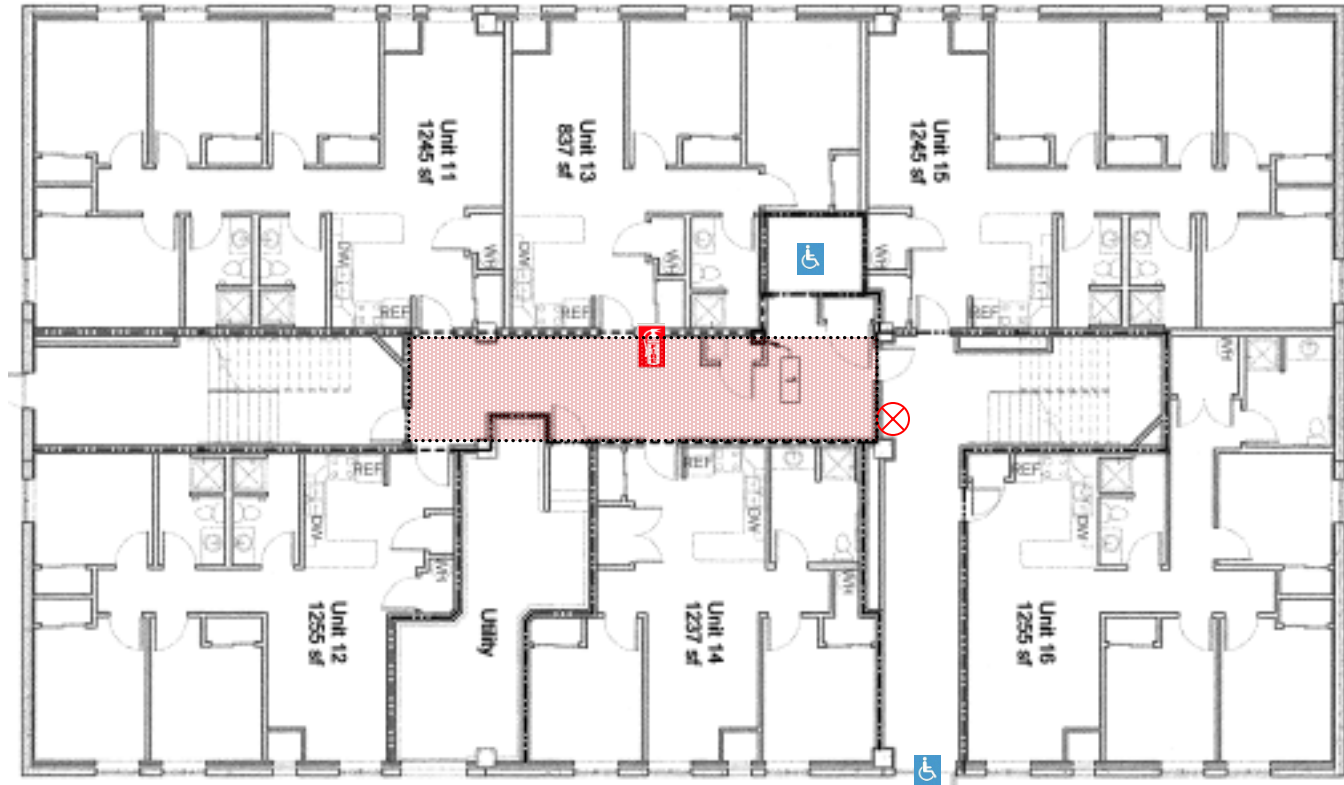

IF THERE IS AN EVACUATION EMERGENCY:

- Assist persons with disabilities
- Exit the building using the nearest exit **DO NOT USE ELEVATORS!**
- Report to the nearest designated area.
- Call 911 (9-911 if on a campus phone)
- Call Public Safety at 605-394-6100
- Do not re-enter until authorized to do so.

CAMPUS ESCORT SERVICE:

Public Safety Provides Escort Services: To arrange an escort, call 605-394-6100, and a Public Safety Employee will escort you from any campus building to another.

Rocker Square 2 – 1st Floor

Campus Emergency Numbers

Emergency 911 (9-911 from a campus phone)

SDSMT Public Safety (605)394-6100

Emergency Information Recording (605)394-2210



















SOUTH DAKOTA MINES

An engineering, science and technology university

Building Managers

Katie Wahls
Bryce Nussbaum

KEY

-  You Are Here
-  Evacuation Route
-  Exit
-  Emergency Assembly Point
-  Restroom
-  Automated External Defibrillator
-  Fire Extinguisher
-  Fire Alarm (Pull Station)
-  Fire Alarm Control Panel
-  Fire Sprinkler Shut-off
-  Stand Pipe or FDC
-  Symbol of Accessibility
-  Tornado/Severe Thunderstorm
Refuge Areas
-  First Aid Kit
-  Eye Wash/Safety Shower
-  Spill Kit

In the event of a tornado, please proceed to areas marked on the first floor map.

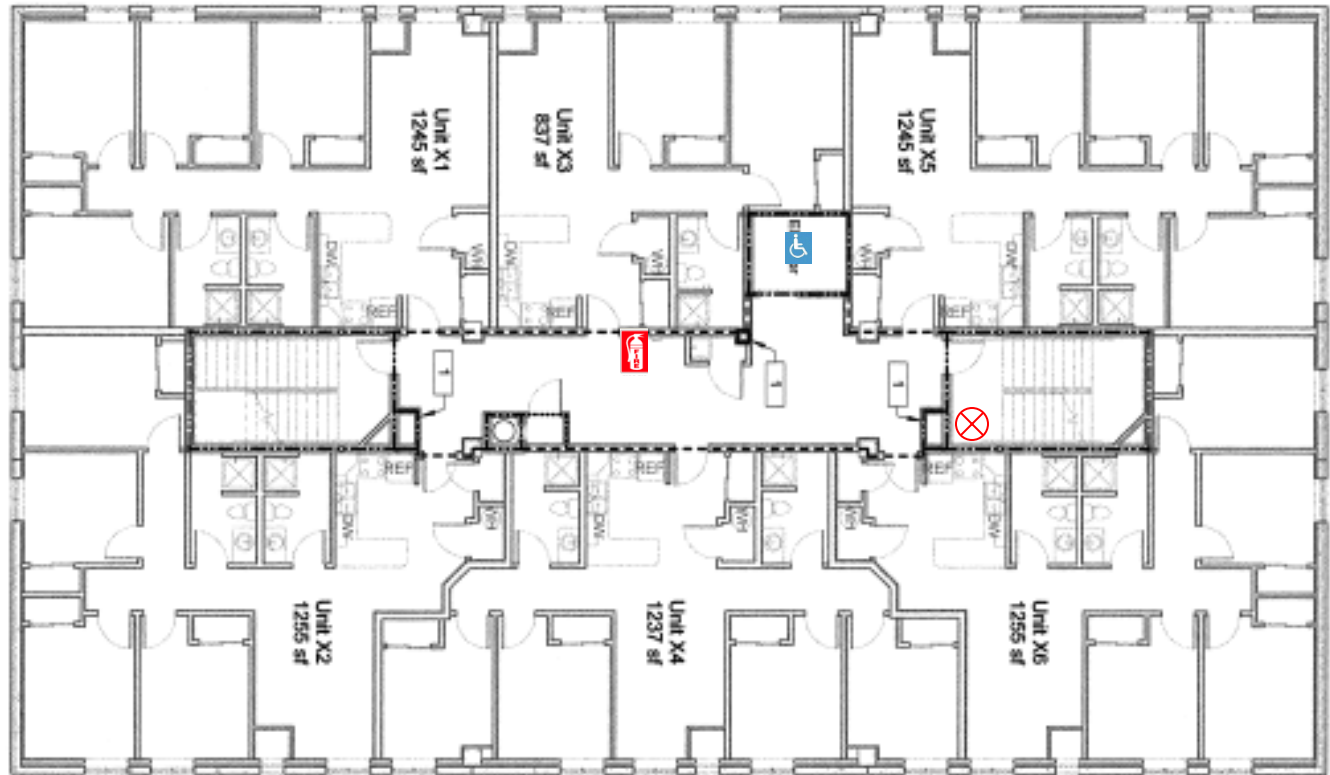

IF THERE IS AN EVACUATION EMERGENCY:

- Assist persons with disabilities
- Exit the building using the nearest exit **DO NOT USE ELEVATORS!**
- Report to the nearest designated area.
- Call 911 (9-911 if on a campus phone)
- Call Public Safety at 605-394-6100
- Do not re-enter until authorized to do so.

CAMPUS ESCORT SERVICE:

Public Safety Provides Escort Services: To arrange an escort, call 605-394-6100, and a Public Safety Employee will escort you from any campus building to another.

Rucker Square 2 – 2nd Floor

Campus Emergency Numbers

Emergency 911 (9-911 from a campus phone)

SDSMT Public Safety (605)394-6100

Emergency Information Recording (605)394-2210



















SOUTH DAKOTA MINES

An engineering, science and technology university

Building Managers

Katie Wahls
Bryce Nussbaum

KEY

-  You Are Here
-  Evacuation Route
-  Exit
-  Emergency Assembly Point
-  Restroom
-  Automated External Defibrillator
-  Fire Extinguisher
-  Fire Alarm (Pull Station)
-  Fire Alarm Control Panel
-  Fire Sprinkler Shut-off
-  Stand Pipe or FDC
-  Symbol of Accessibility
-  Tornado/Severe Thunderstorm
Refuge Areas
-  First Aid Kit
-  Eye Wash/Safety Shower
-  Spill Kit

In the event of a tornado, please proceed to areas marked on the first floor map.

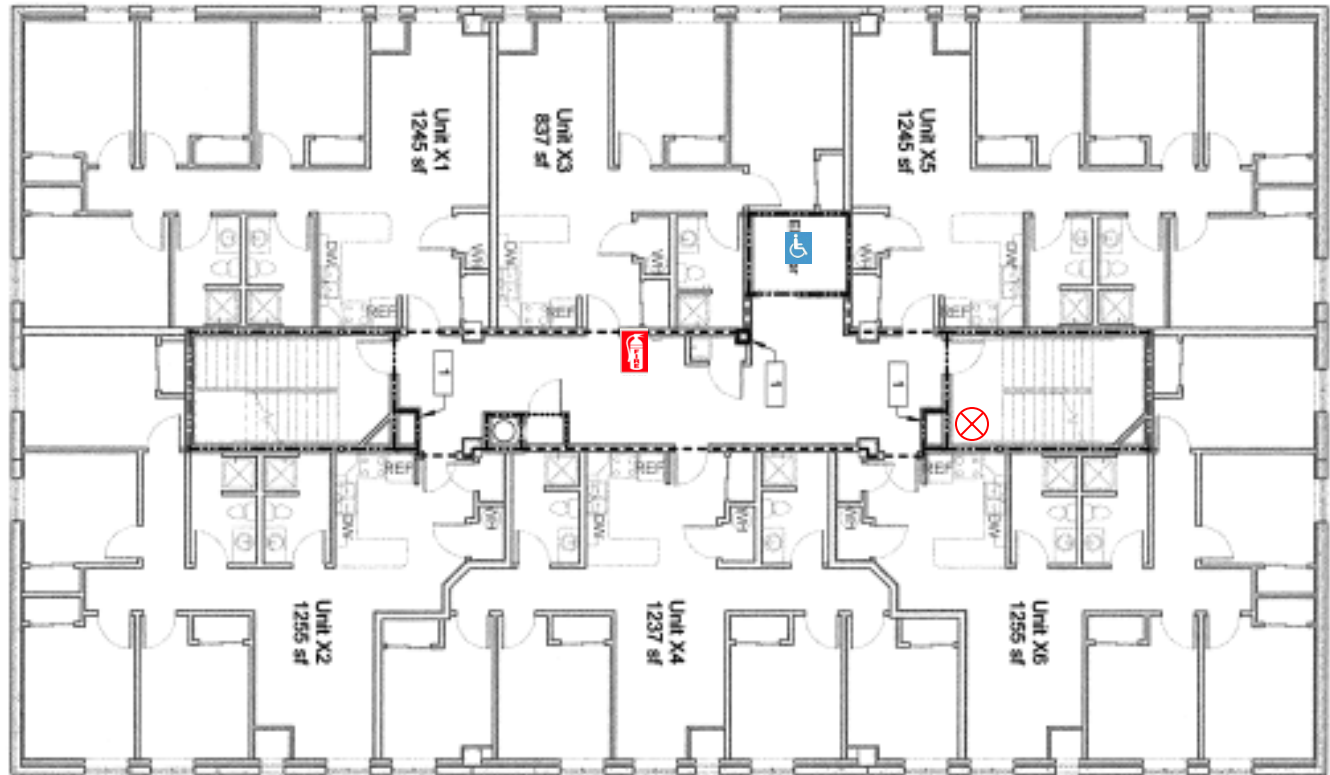

IF THERE IS AN EVACUATION EMERGENCY:

- Assist persons with disabilities
- Exit the building using the nearest exit **DO NOT USE ELEVATORS!**
- Report to the nearest designated area.
- Call 911 (9-911 if on a campus phone)
- Call Public Safety at 605-394-6100
- Do not re-enter until authorized to do so.

CAMPUS ESCORT SERVICE:

Public Safety Provides Escort Services: To arrange an escort, call 605-394-6100, and a Public Safety Employee will escort you from any campus building to another.

Rucker Square 2 – 3rd Floor

Campus Emergency Numbers

Emergency 911 (9-911 from a campus phone)

SDSMT Public Safety (605)394-6100

Emergency Information Recording (605)394-2210



















SOUTH DAKOTA MINES

An engineering, science and technology university

Building Managers

Katie Wahls
Bryce Nussbaum

KEY

-  You Are Here
-  Evacuation Route
-  Exit
-  Emergency Assembly Point
-  Restroom
-  Automated External Defibrillator
-  Fire Extinguisher
-  Fire Alarm (Pull Station)
-  Fire Alarm Control Panel
-  Fire Sprinkler Shut-off
-  Stand Pipe or FDC
-  Symbol of Accessibility
-  Tornado/Severe Thunderstorm
Refuge Areas
-  First Aid Kit
-  Eye Wash/Safety Shower
-  Spill Kit

In the event of a tornado, please proceed to areas marked on the first floor map.

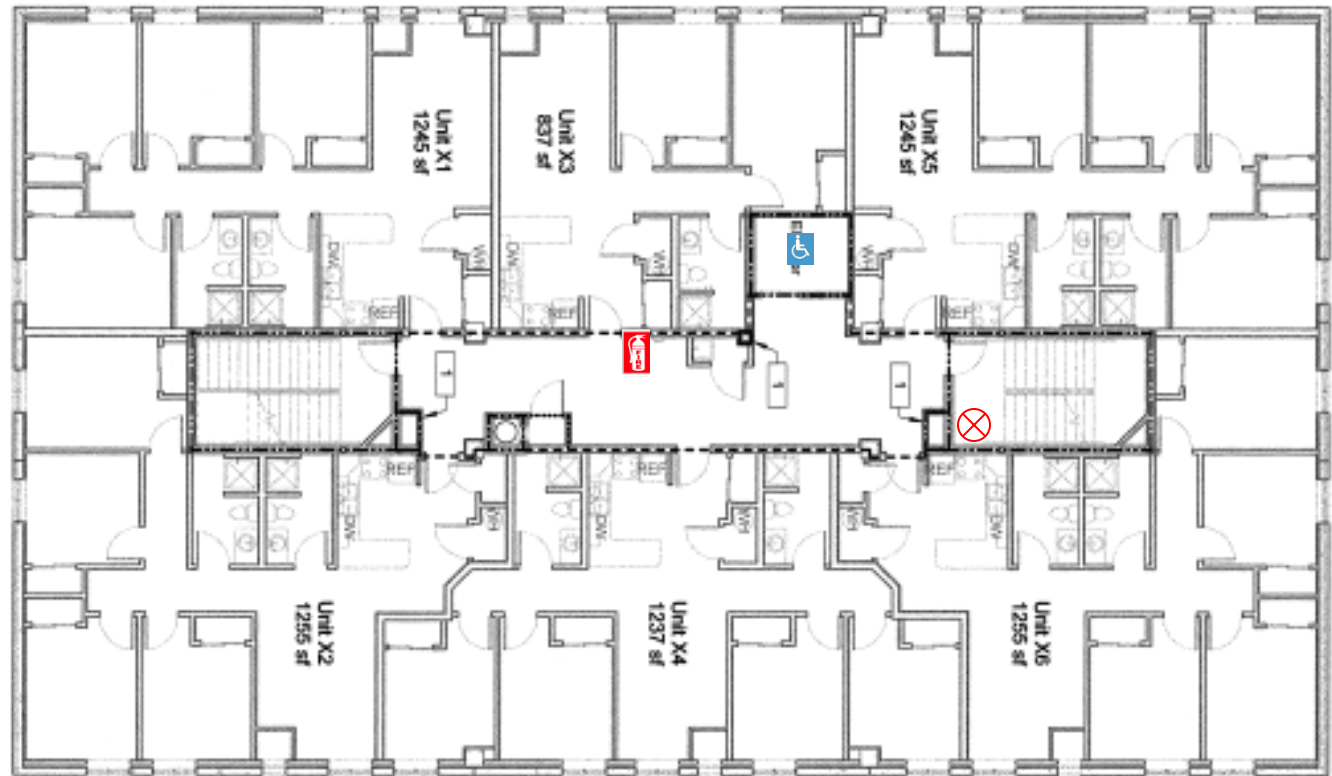

IF THERE IS AN EVACUATION EMERGENCY:

- Assist persons with disabilities
- Exit the building using the nearest exit **DO NOT USE ELEVATORS!**
- Report to the nearest designated area.
- Call 911 (9-911 if on a campus phone)
- Call Public Safety at 605-394-6100
- Do not re-enter until authorized to do so.

CAMPUS ESCORT SERVICE:

Public Safety Provides Escort Services: To arrange an escort, call 605-394-6100, and a Public Safety Employee will escort you from any campus building to another.

Rucker Square 2 – 4th Floor

Campus Emergency Numbers

Emergency 911 (9-911 from a campus phone)

SDSMT Public Safety (605)394-6100

Emergency Information Recording (605)394-2210



















SOUTH DAKOTA MINES

An engineering, science and technology university

Building Managers

Katie Wahls
Bryce Nussbaum

KEY

-  You Are Here
-  Evacuation Route
-  Exit
-  Emergency Assembly Point
-  Restroom
-  Automated External Defibrillator
-  Fire Extinguisher
-  Fire Alarm (Pull Station)
-  Fire Alarm Control Panel
-  Fire Sprinkler Shut-off
-  Stand Pipe or FDC
-  Symbol of Accessibility
-  Tornado/Severe Thunderstorm
Refuge Areas
-  First Aid Kit
-  Eye Wash/Safety Shower
-  Spill Kit

In the event of a tornado, please proceed to areas marked on the first floor map.

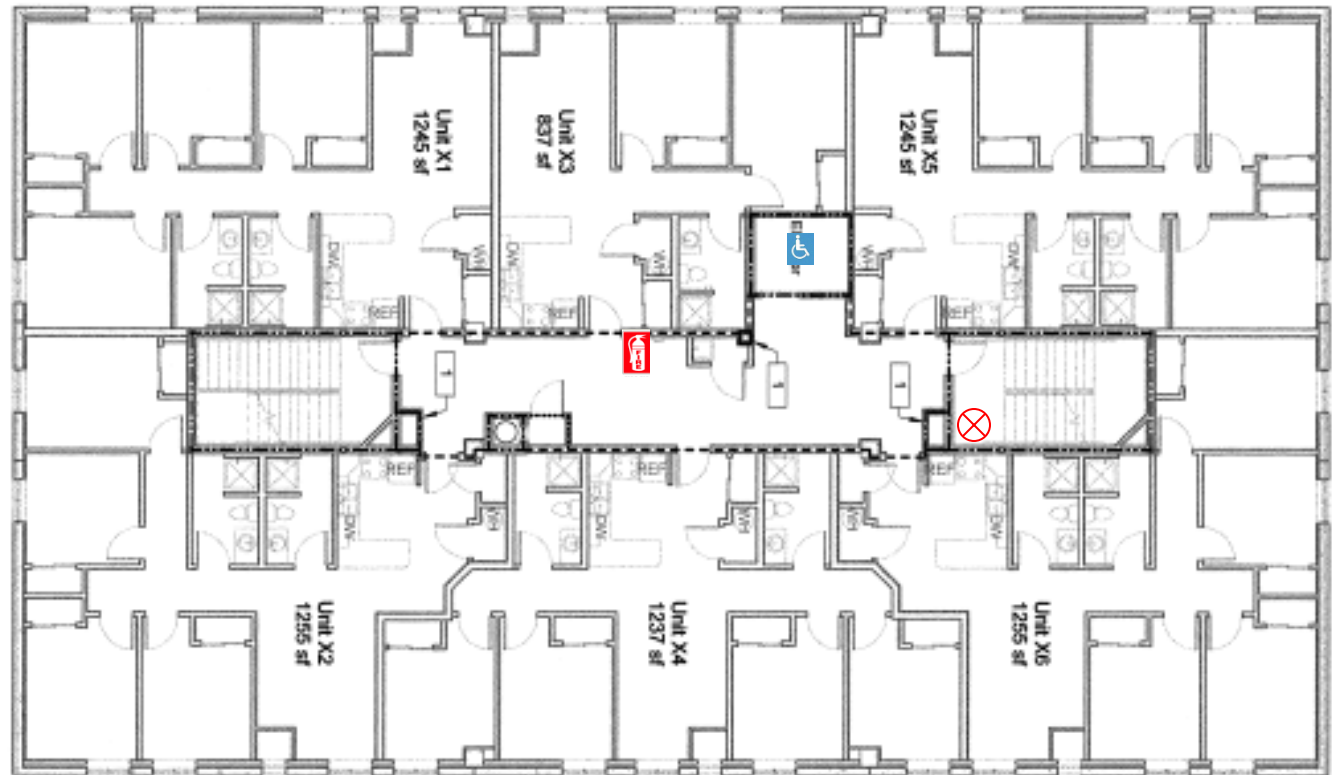

IF THERE IS AN EVACUATION EMERGENCY:

- Assist persons with disabilities
- Exit the building using the nearest exit **DO NOT USE ELEVATORS!**
- Report to the nearest designated area.
- Call 911 (9-911 if on a campus phone)
- Call Public Safety at 605-394-6100
- Do not re-enter until authorized to do so.

CAMPUS ESCORT SERVICE:

Public Safety Provides Escort Services: To arrange an escort, call 605-394-6100, and a Public Safety Employee will escort you from any campus building to another.

Rucker Square 2 – 5th Floor

Campus Emergency Numbers

Emergency 911 (9-911 from a campus phone)

SDSMT Public Safety (605)394-6100

Emergency Information Recording (605)394-2210



















SOUTH DAKOTA MINES

An engineering, science and technology university

Building Managers

Katie Wahls
Bryce Nussbaum

KEY

-  You Are Here
-  Evacuation Route
-  Exit
-  Emergency Assembly Point
-  Restroom
-  Automated External Defibrillator
-  Fire Extinguisher
-  Fire Alarm (Pull Station)
-  Fire Alarm Control Panel
-  Fire Sprinkler Shut-off
-  Stand Pipe or FDC
-  Symbol of Accessibility
-  Tornado/Severe Thunderstorm
Refuge Areas
-  First Aid Kit
-  Eye Wash/Safety Shower
-  Spill Kit

In the event of a tornado, please proceed to areas marked on the first floor map.

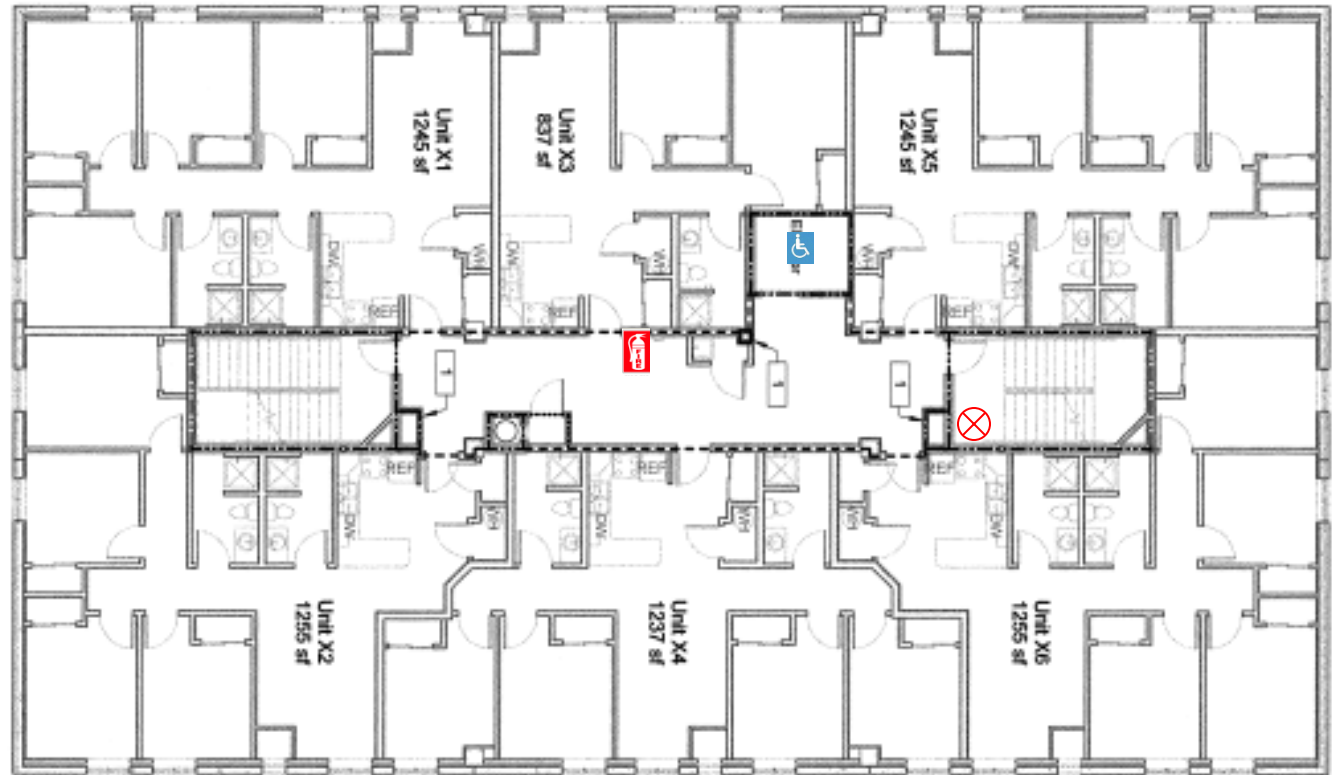

IF THERE IS AN EVACUATION EMERGENCY:

- Assist persons with disabilities
- Exit the building using the nearest exit **DO NOT USE ELEVATORS!**
- Report to the nearest designated area.
- Call 911 (9-911 if on a campus phone)
- Call Public Safety at 605-394-6100
- Do not re-enter until authorized to do so.

CAMPUS ESCORT SERVICE:

Public Safety Provides Escort Services: To arrange an escort, call 605-394-6100, and a Public Safety Employee will escort you from any campus building to another.

Rocker Square 2 – 6th Floor

Campus Emergency Numbers

Emergency 911 (9-911 from a campus phone)

SDSMT Public Safety (605)394-6100

Emergency Information Recording (605)394-2210



SOUTH DAKOTA MINES

An engineering, science and technology university

















Building Managers

Stephanie Lindsley

Cory Headley

Duff Holcomb

KEY

-  You Are Here
-  Evacuation Route
-  Exit
-  Emergency Assembly Point
-  Restroom
-  Automated External Defibrillator
-  Fire Extinguisher
-  Fire Alarm (Pull Station)
-  Fire Alarm Control Panel
-  Fire Sprinkler Shut-off
-  Stand Pipe or FDC
-  Symbol of Accessibility
-  Tornado/Severe Thunderstorm Refuge Areas
-  First Aid Kit
-  Eye Wash/Safety Shower
-  Spill Kit



The Emergency Assembly Point is located in the March/Dake Plaza.

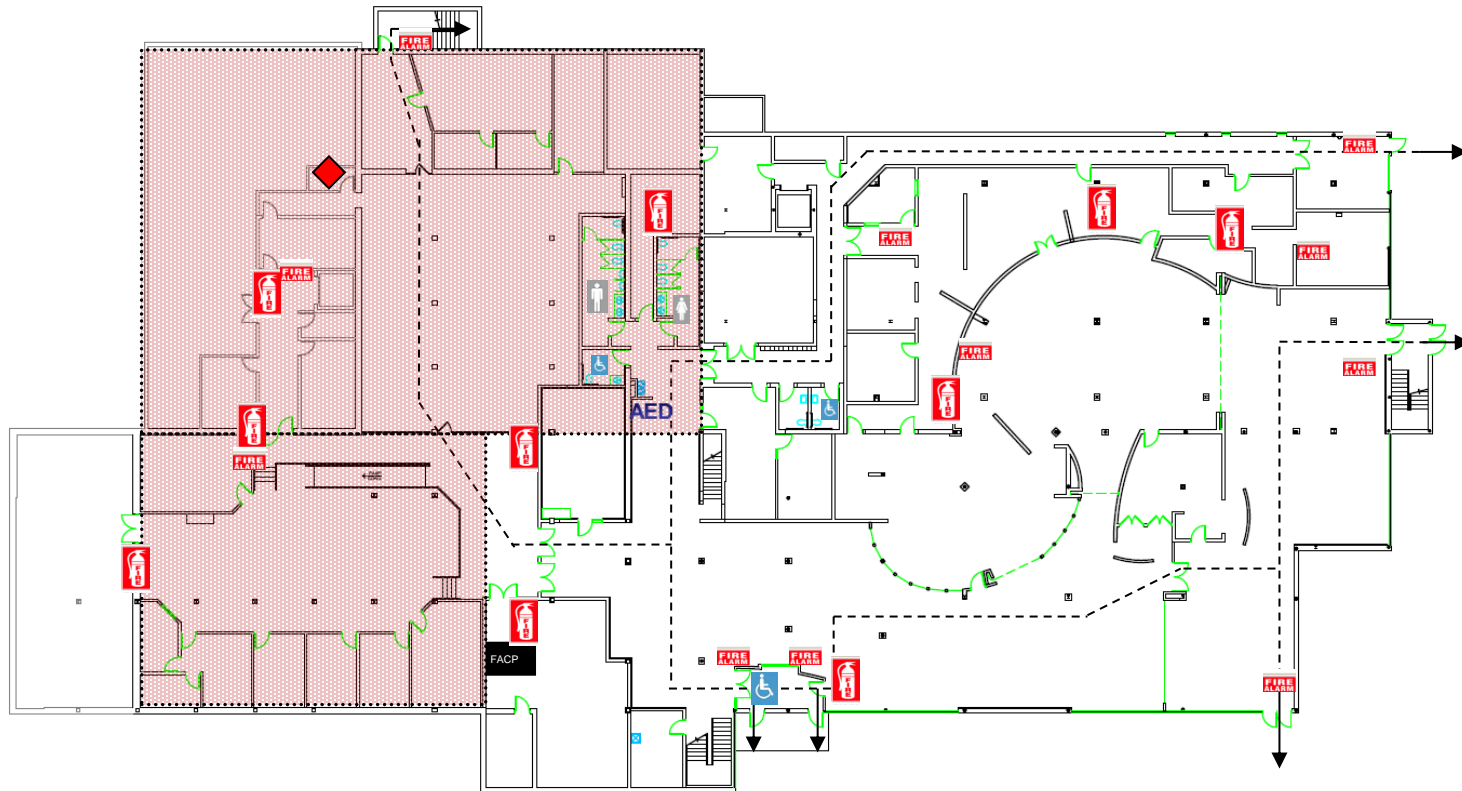
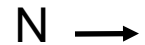

IF THERE IS AN EVACUATION EMERGENCY:

- Assist persons with disabilities
- Exit the building using the nearest exit **DO NOT USE ELEVATORS!**
- Report to the nearest designated area.
- Call 911 (9-911 if on a campus phone)
- Call Public Safety at 605-394-6100
- Do not re-enter until authorized to do so.

CAMPUS ESCORT SERVICE:

Public Safety Provides Escort Services: To arrange an escort, call 605-394-6100, and a Public Safety Employee will escort you from any campus building to another.

Surbeck Center – Lower Level

Campus Emergency Numbers

Emergency 911 (9-911 from a campus phone)

SDSMT Public Safety (605)394-6100

Emergency Information Recording (605)394-2210



SOUTH DAKOTA MINES

An engineering, science and technology university

















Building Managers

Stephanie Lindsley

Cory Headley

Duff Holcomb

KEY

-  You Are Here
-  Evacuation Route
-  Exit
-  Emergency Assembly Point
-  Restroom
-  Automated External Defibrillator
-  Fire Extinguisher
-  Fire Alarm (Pull Station)
-  Fire Alarm Control Panel
-  Fire Sprinkler Shut-off
-  Stand Pipe or FDC
-  Symbol of Accessibility
-  Tornado/Severe Thunderstorm
Refuge Areas
-  First Aid Kit
-  Eye Wash/Safety Shower
-  Spill Kit



The Emergency Assembly Point is located in the March/Dake Plaza.

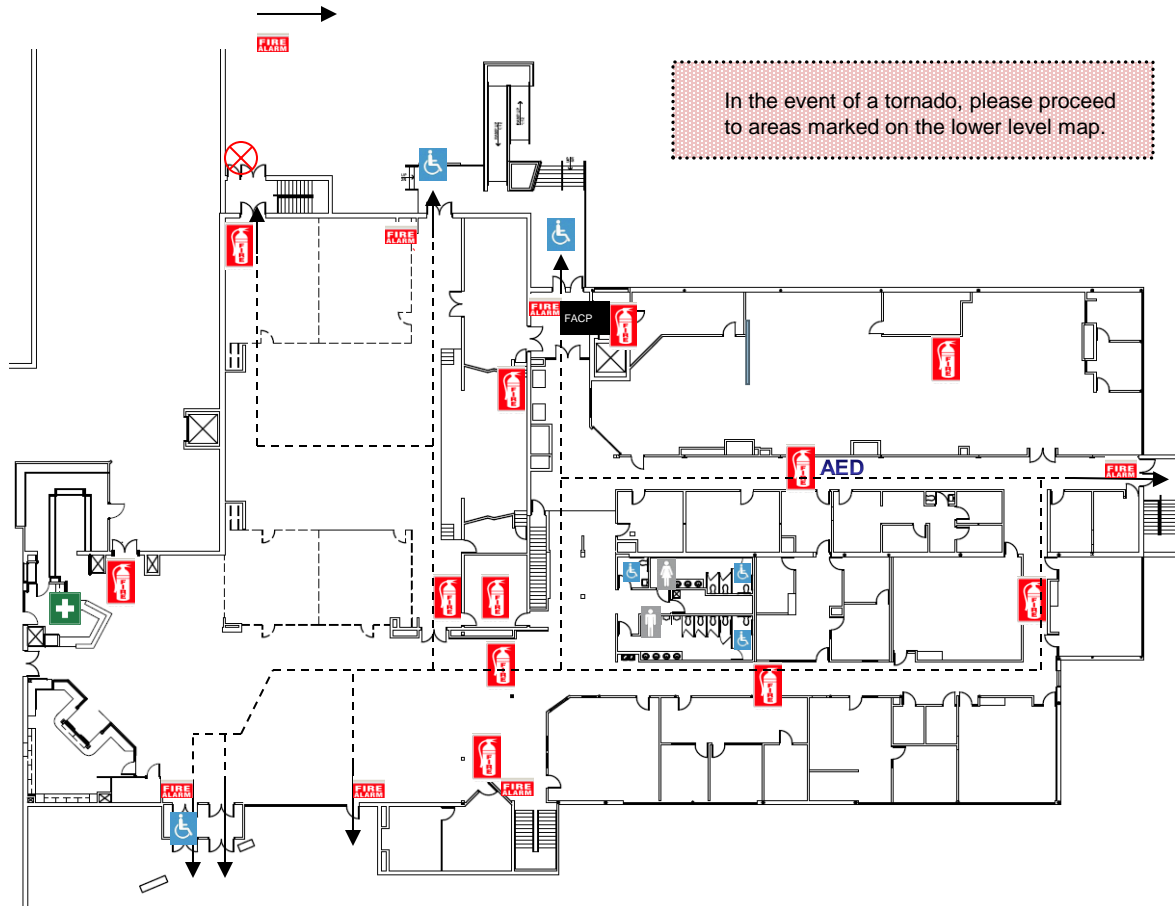
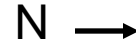

In the event of a tornado, please proceed to areas marked on the lower level map.

IF THERE IS AN EVACUATION EMERGENCY:

- Assist persons with disabilities
- Exit the building using the nearest exit **DO NOT USE ELEVATORS!**
- Report to the nearest designated area.
- Call 911 (9-911 if on a campus phone)
- Call Public Safety at 605-394-6100
- Do not re-enter until authorized to do so.

CAMPUS ESCORT SERVICE:

Public Safety Provides Escort Services: To arrange an escort, call 605-394-6100, and a Public Safety Employee will escort you from any campus building to another.

Surbeck Center – Main Level

Campus Emergency Numbers

Emergency 911 (9-911 from a campus phone)

SDSMT Public Safety (605)394-6100

Emergency Information Recording (605)394-2210



















SOUTH DAKOTA MINES
An engineering, science and technology university

Building Managers

David Salem
Krishnan Veluswamy

KEY

-  You Are Here
-  Evacuation Route
-  Exit
-  Emergency Assembly Point
-  Restroom
-  Automated External Defibrillator
-  Fire Extinguisher
-  Fire Alarm (Pull Station)
-  Fire Alarm Control Panel
-  Fire Sprinkler Shut-off
-  Stand Pipe or FDC
-  Symbol of Accessibility
-  Tornado/Severe Thunderstorm Refuge Areas
-  First Aid Kit
-  Eye Wash/Safety Shower
-  Spill Kit

IF THERE IS AN EVACUATION EMERGENCY:

- Assist persons with disabilities
- Exit the building using the nearest exit **DO NOT USE ELEVATORS!**
- Report to the nearest designated area.
- Call 911 (9-911 if on a campus phone)
- Call Public Safety at 605-394-6100
- Do not re-enter until authorized to do so.

CAMPUS ESCORT SERVICE:

Public Safety Provides Escort Services: To arrange an escort, call 605-394-6100, and a Public Safety Employee will escort you from any campus building to another.

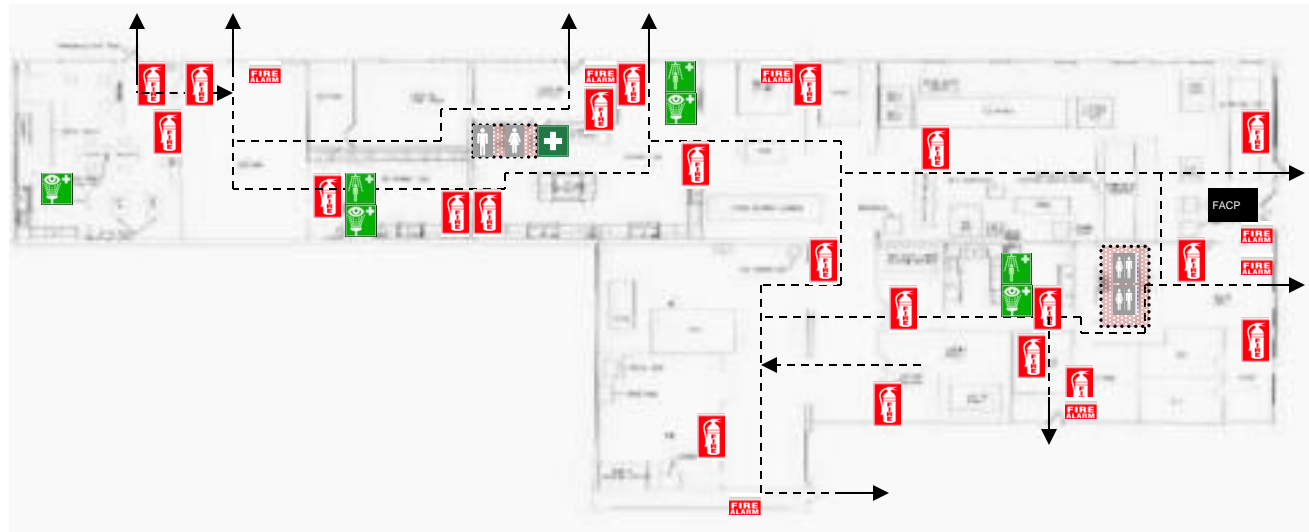
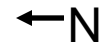

Tech Development Laboratory



EKANSAS CITY ST

BIRCH AVE

CURBECK LN

STEELE AVE

E MAIN ST

LA GROSSE ST

HARDROCK RD

TECHNOLOGY CT

E MAIN ST

STADIUM LN

UNIVERSITY LOOP